



CARDO
FREECOM 4x

POCKETGIDS

NL



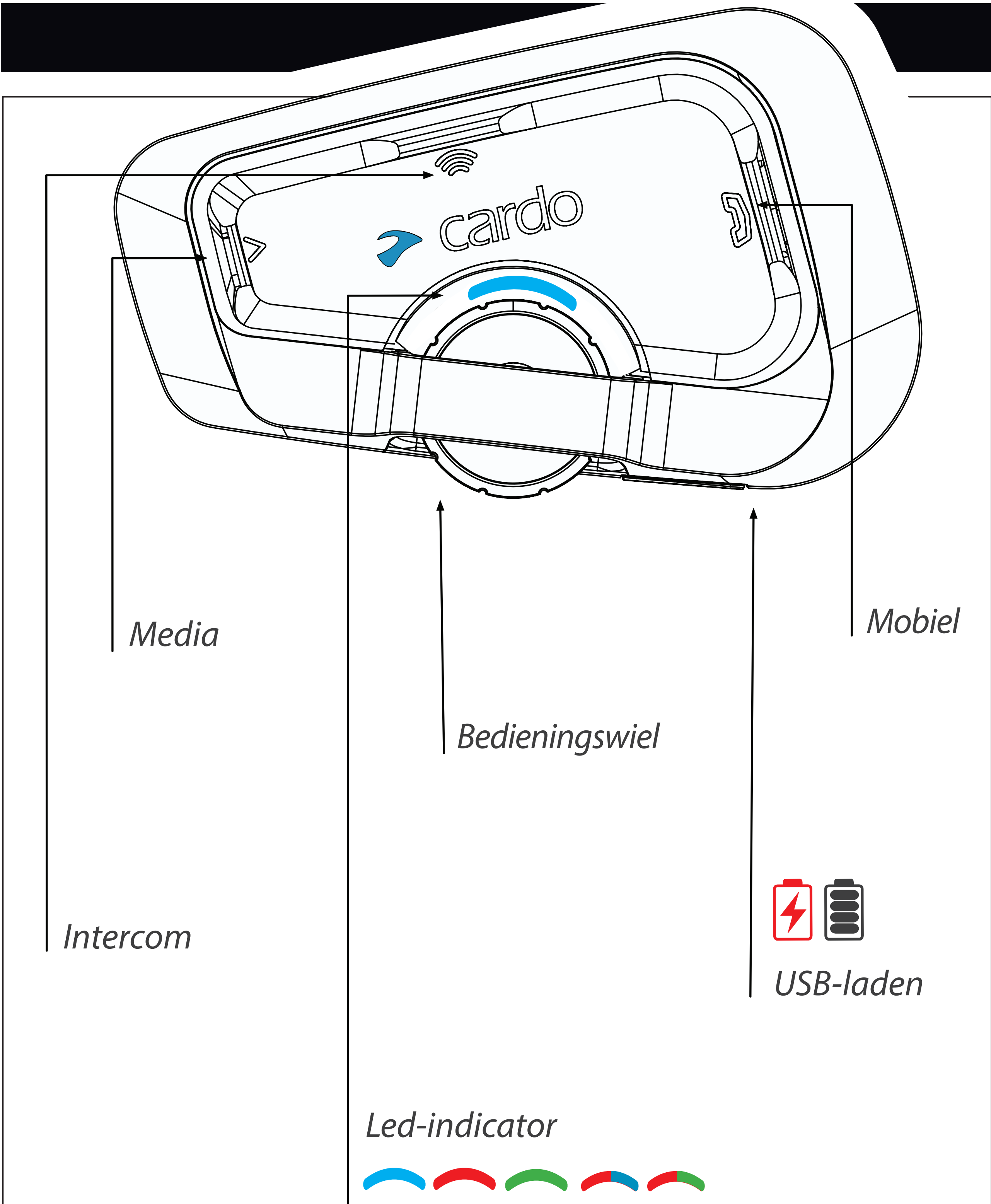

Ingedrukt houden



Aantal keer tikken

Aan de slag

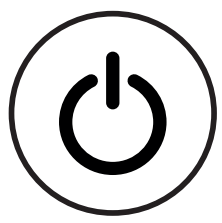

Aan/uit

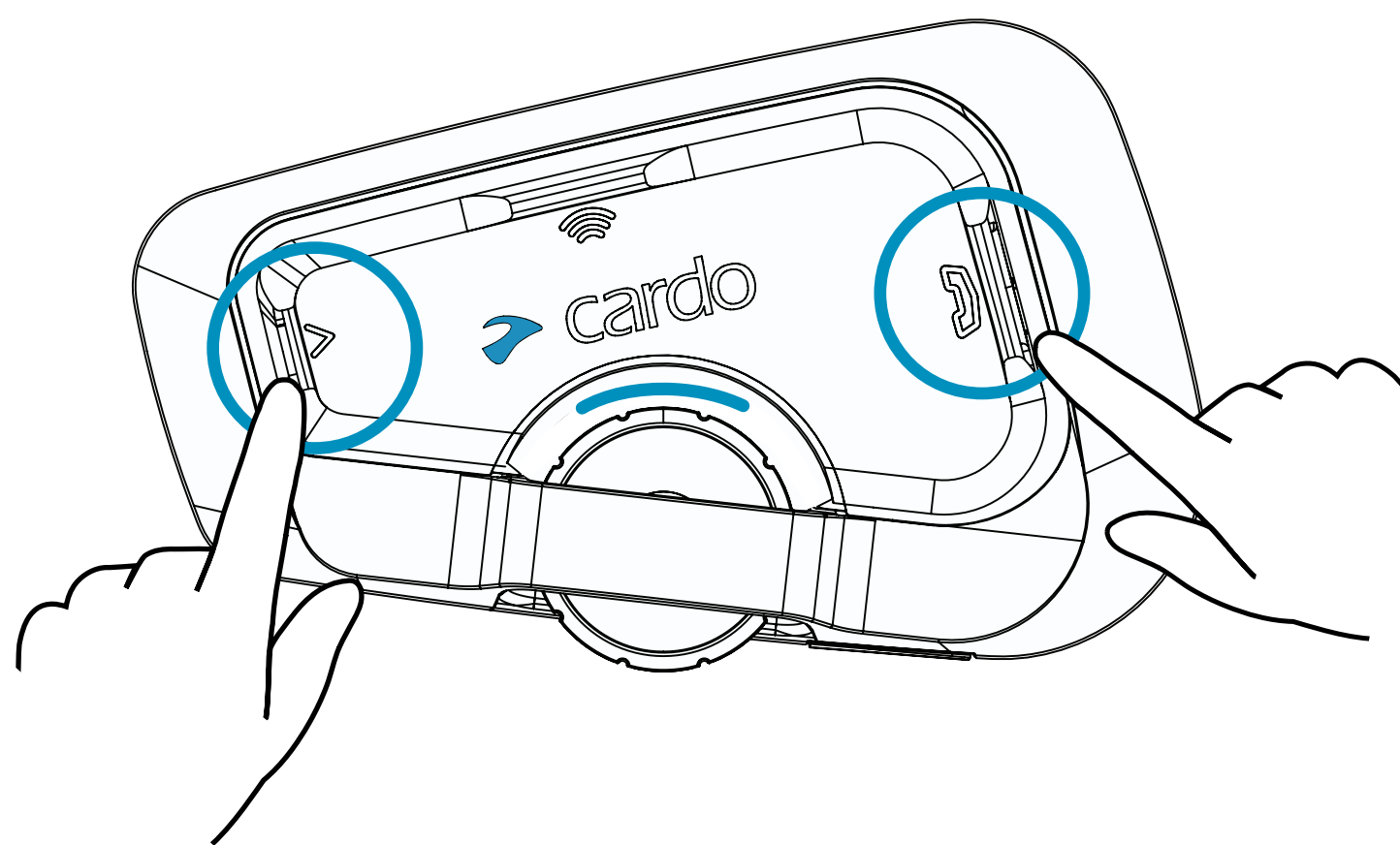

Telefoon koppelen

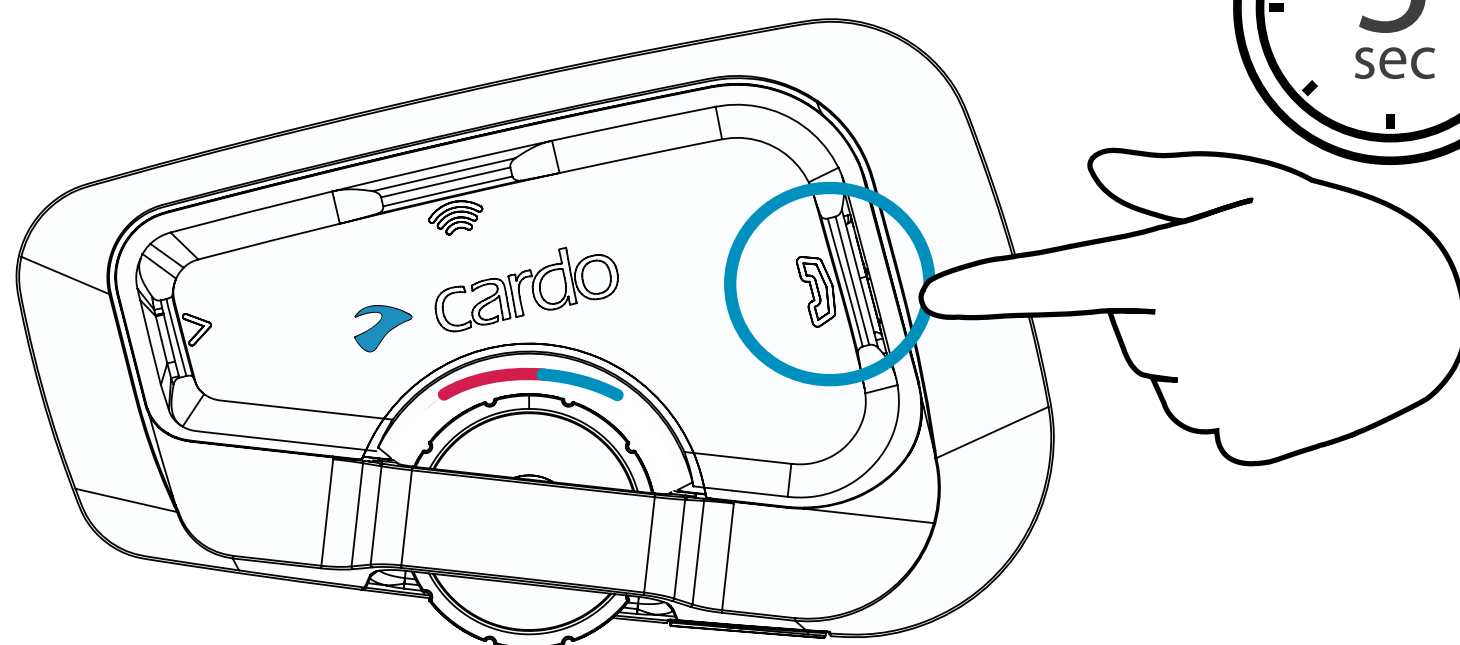

Led rood en blauw 



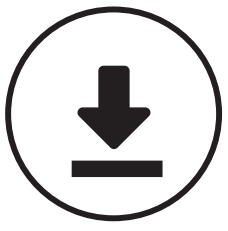

Downloaden



Registreren

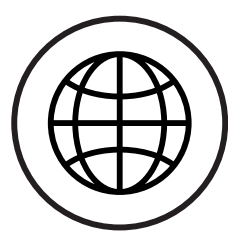
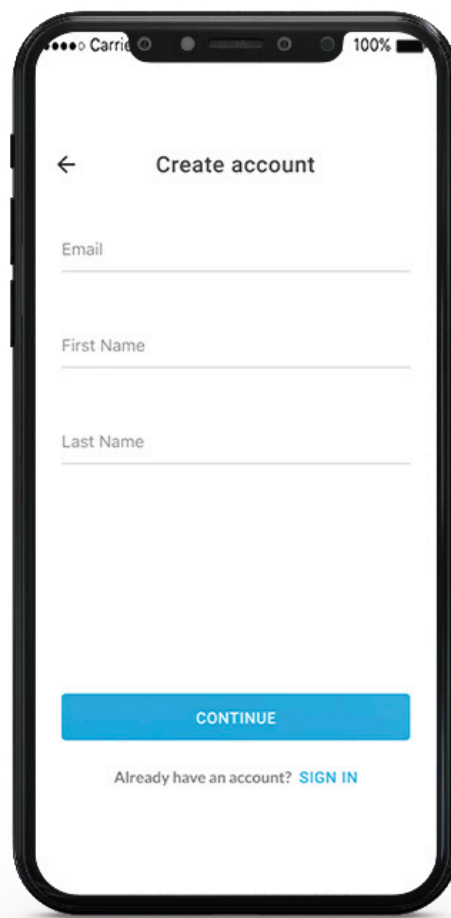

Taal kiezen

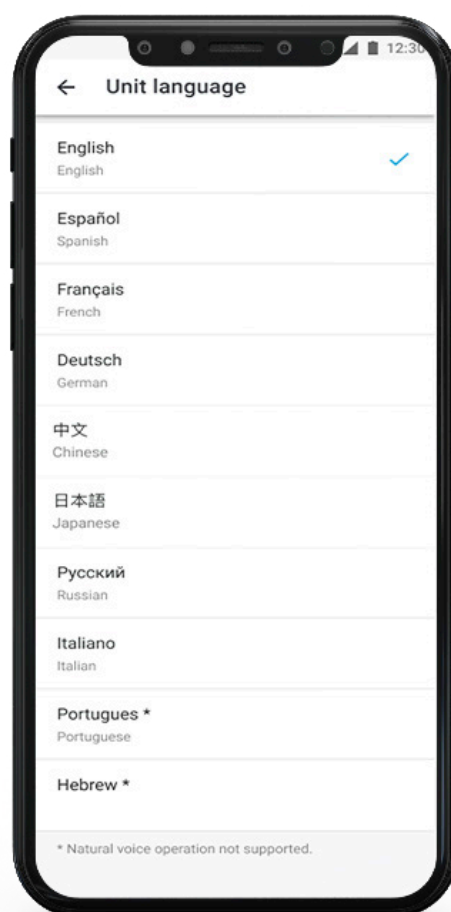

Software-update

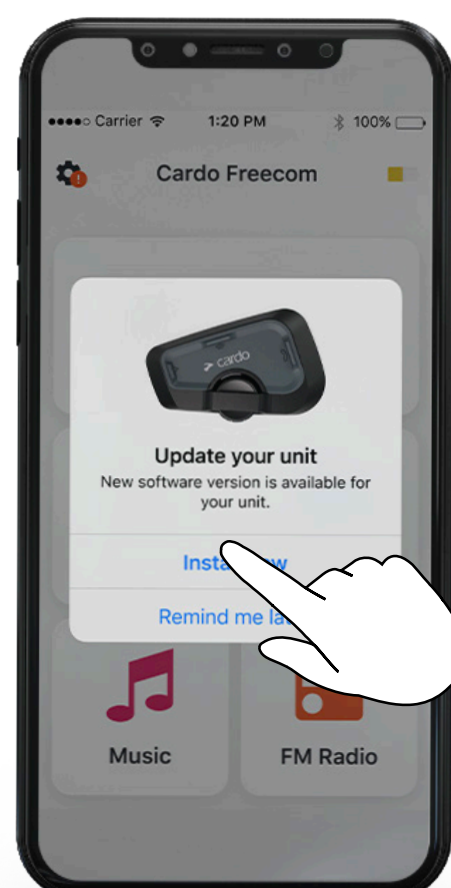

Algemeen

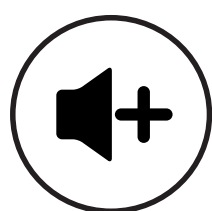

Volume hoger

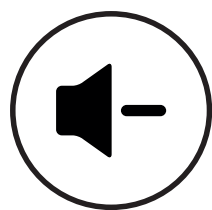
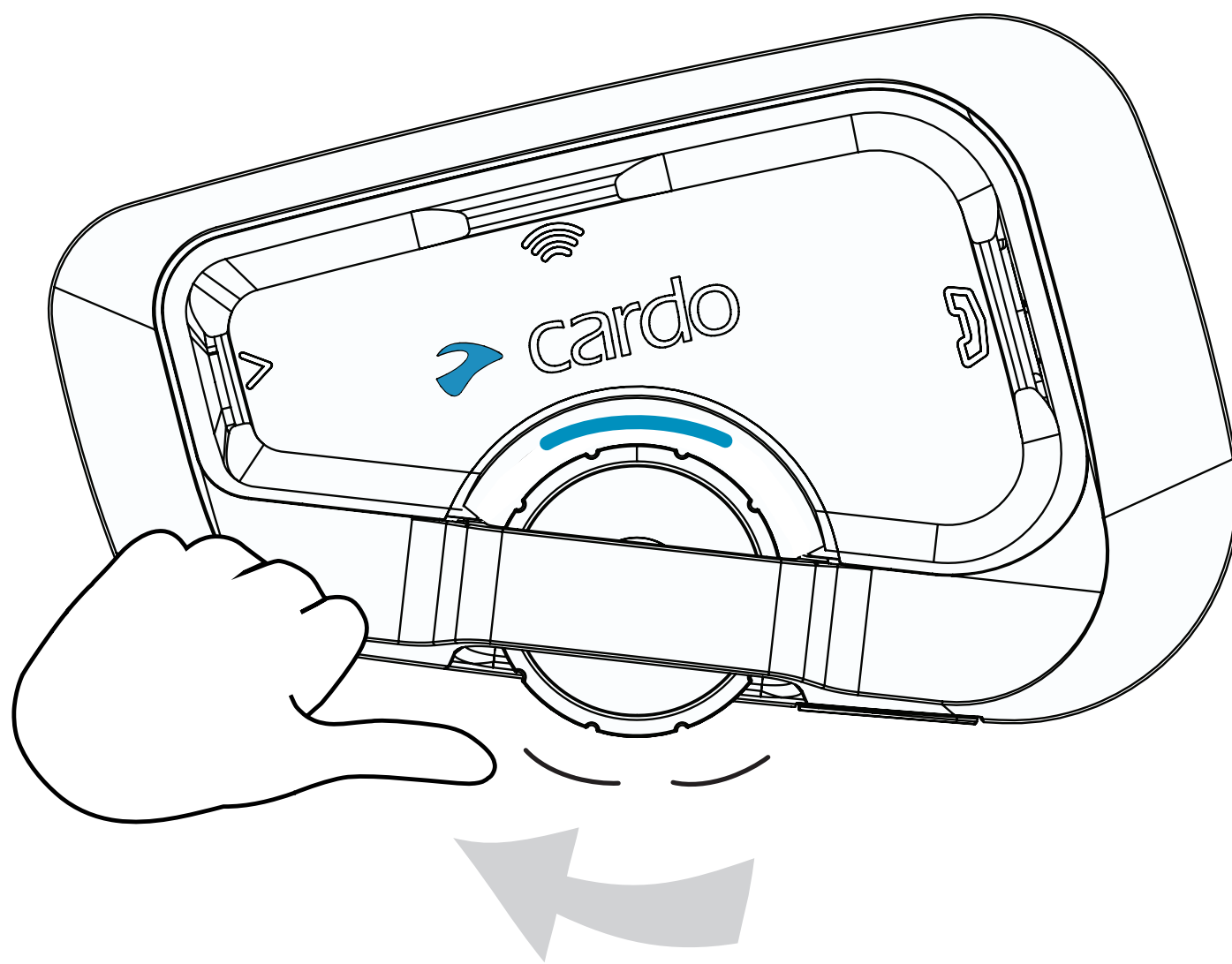

Volume lager

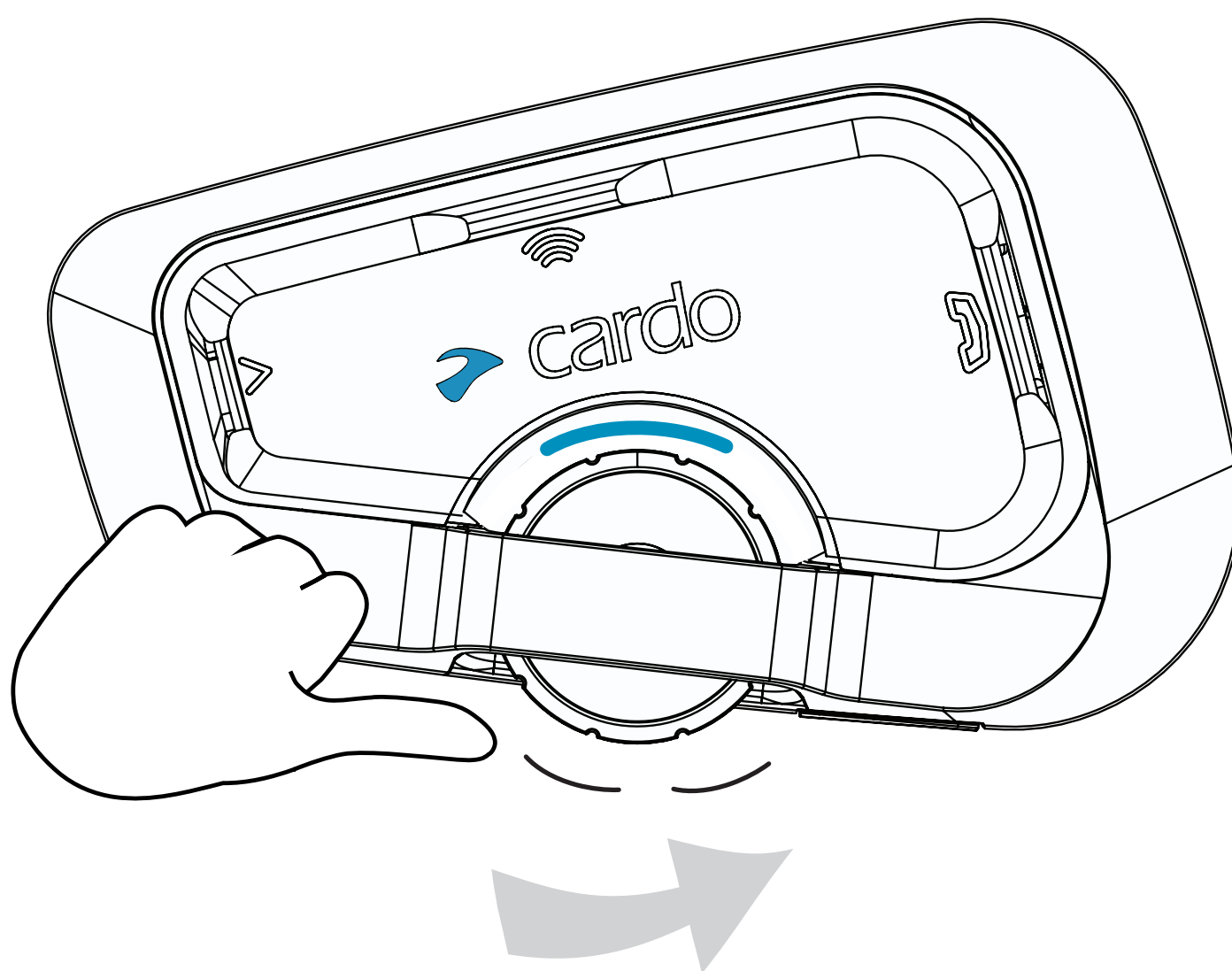

Spraakassistent

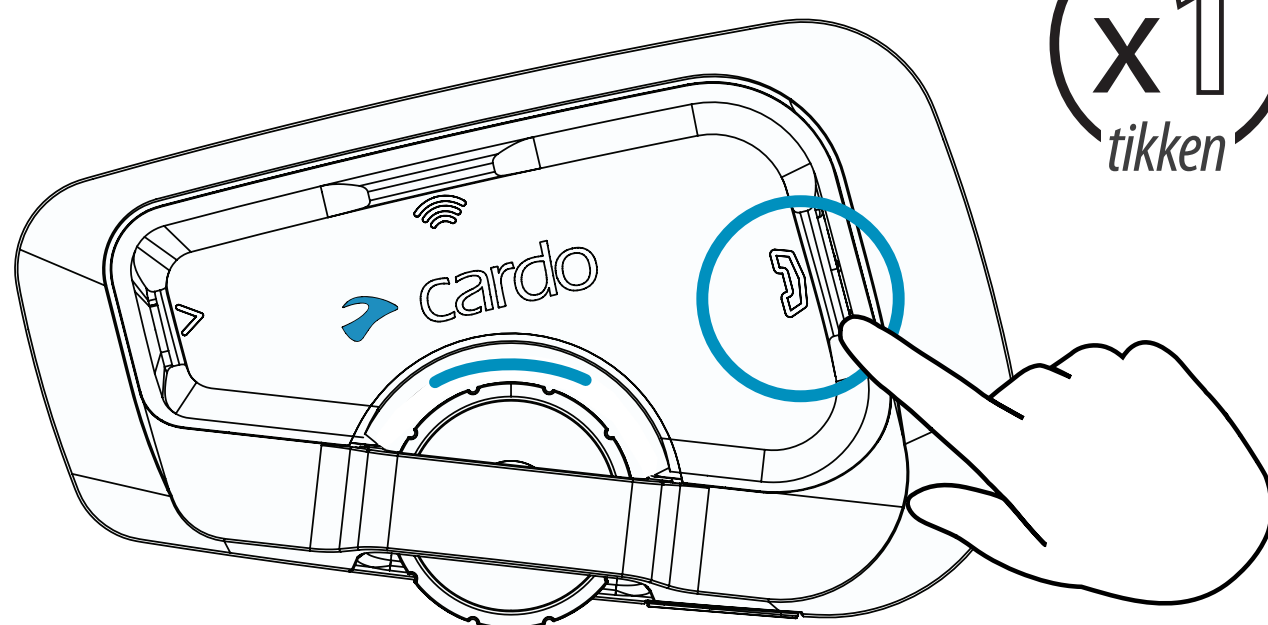

Muziek

 Afspelen

 x1
tikken

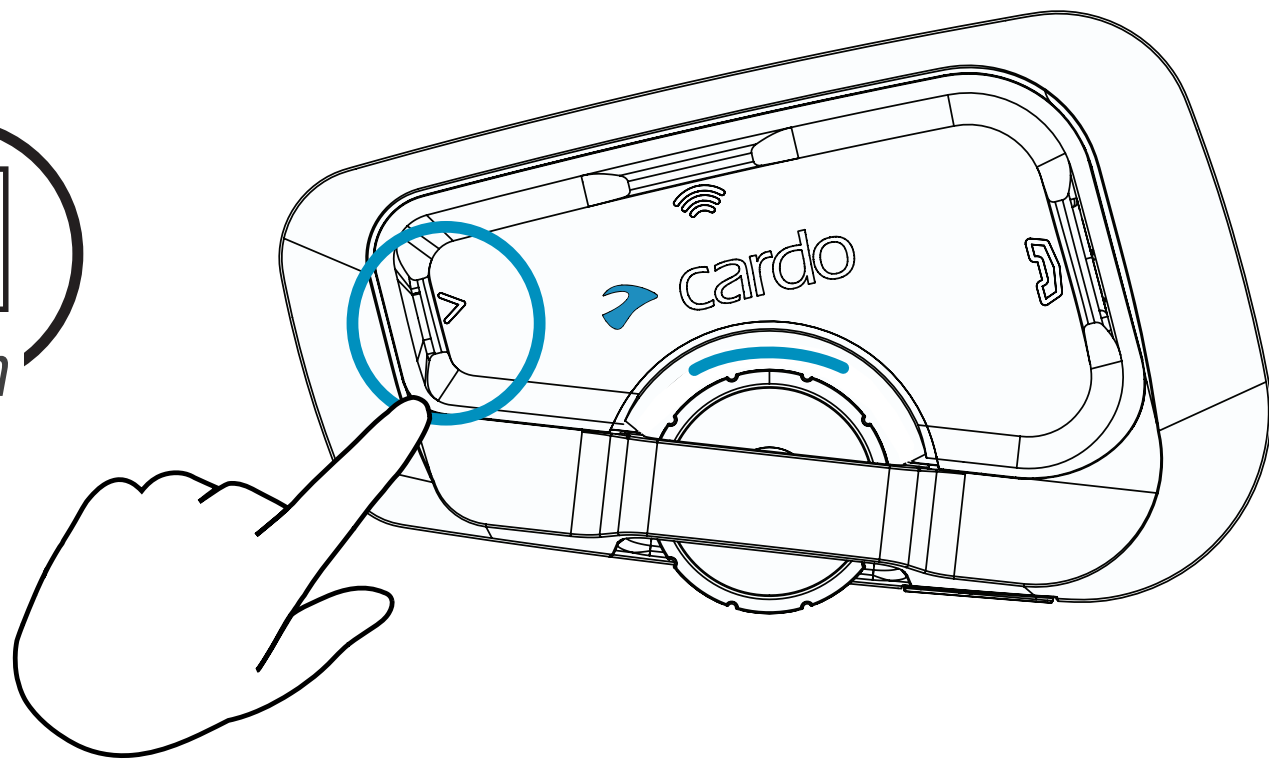

 Pauzeren

 x1
tikken

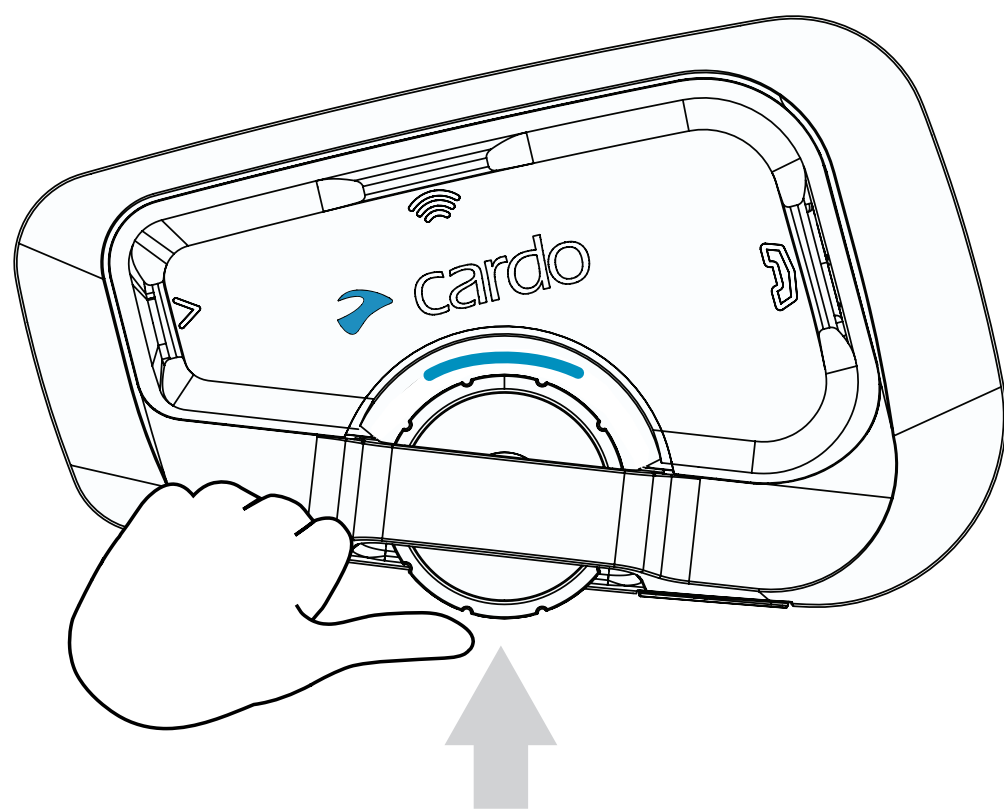

 Volgende

 x1
tikken

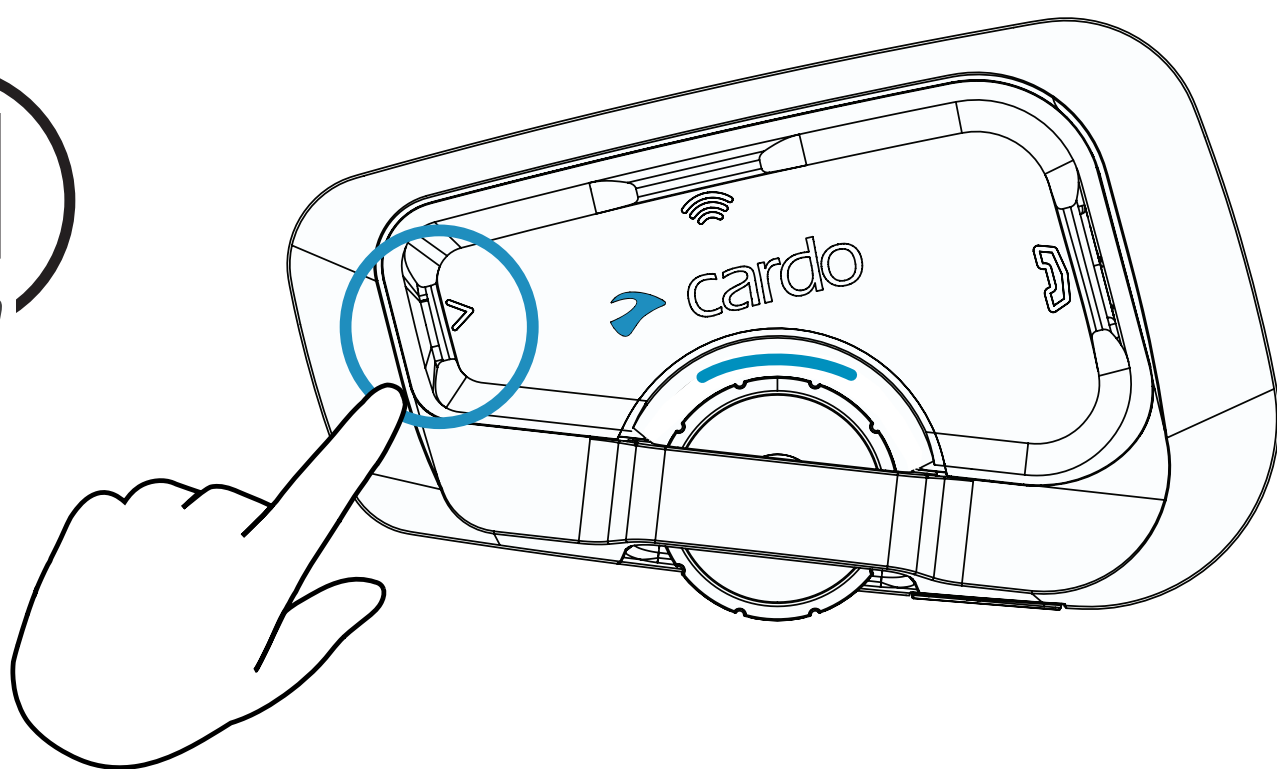

 Vorige

 x2
tikken

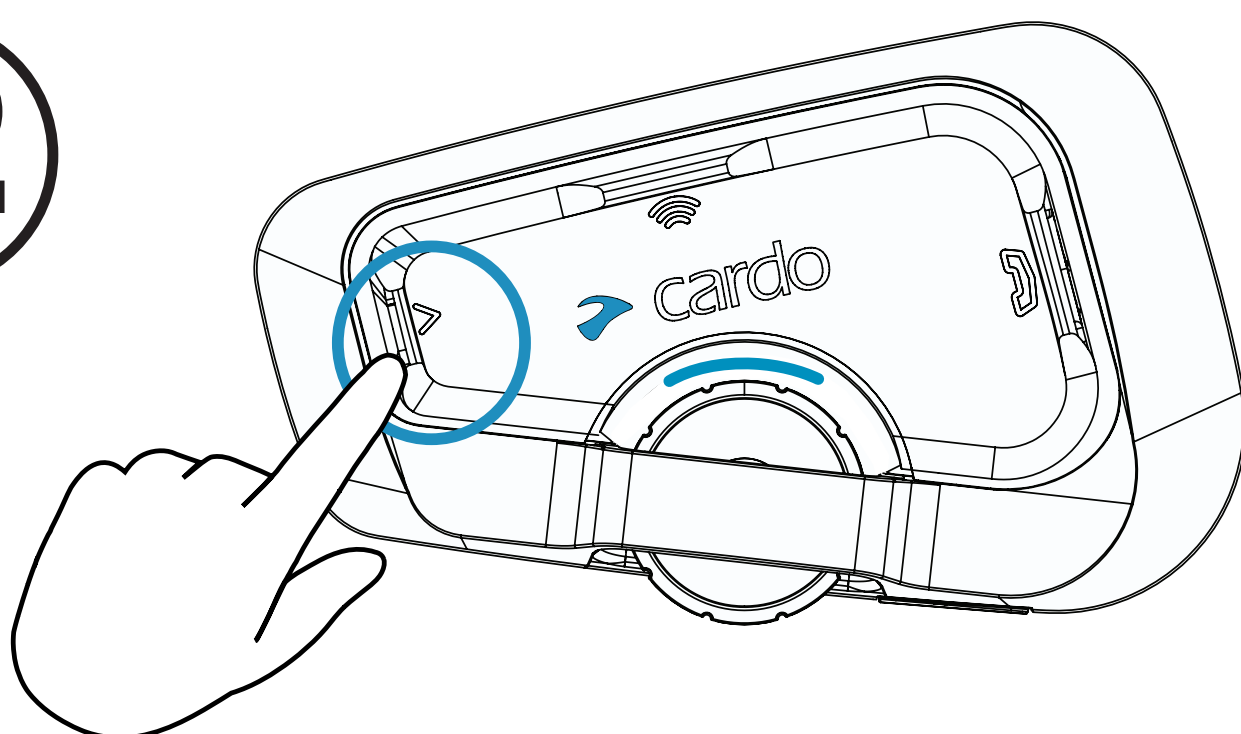

Radio



Voorkeuzezenders instellen

1

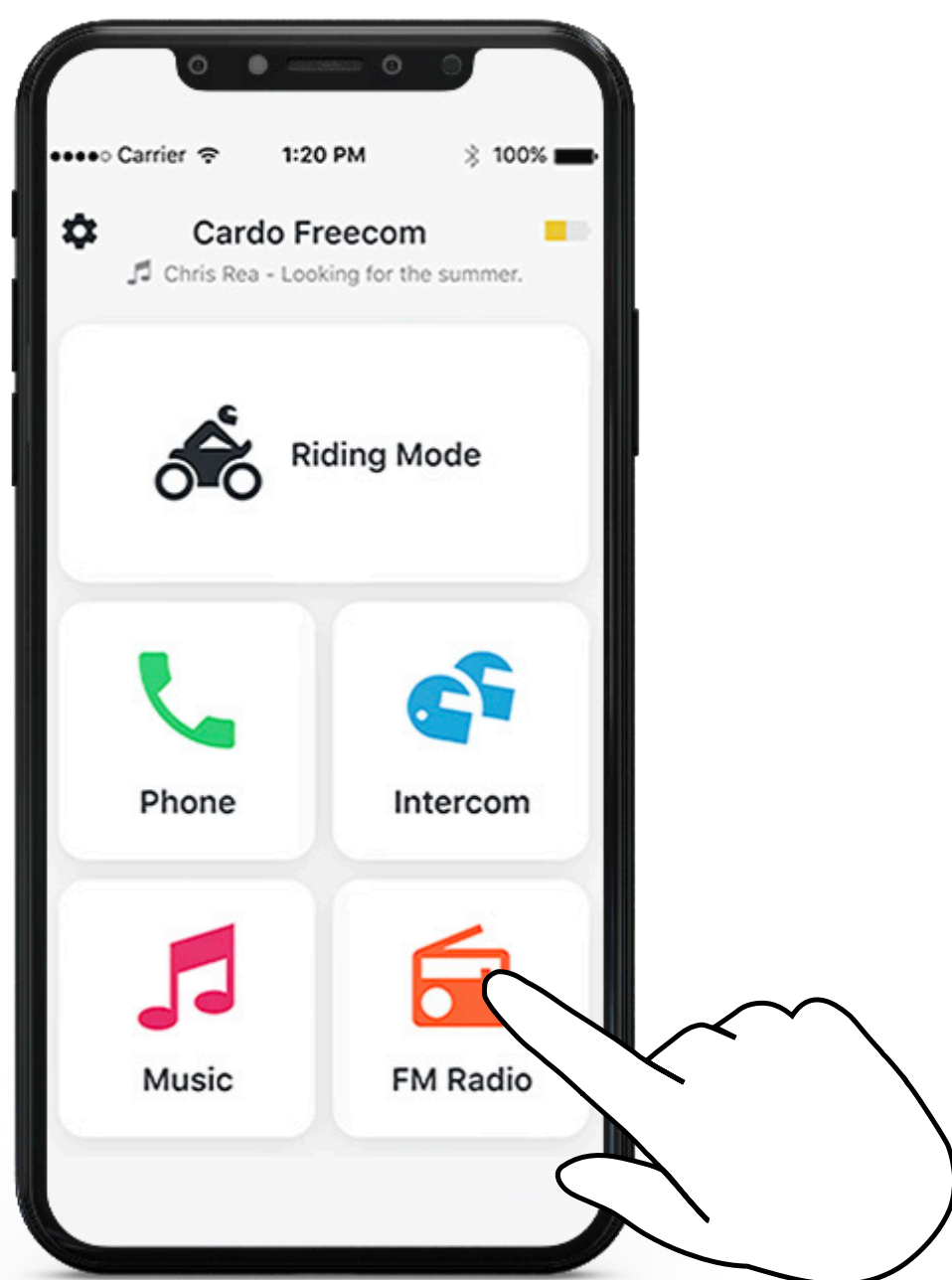

2

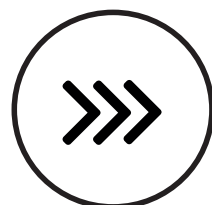
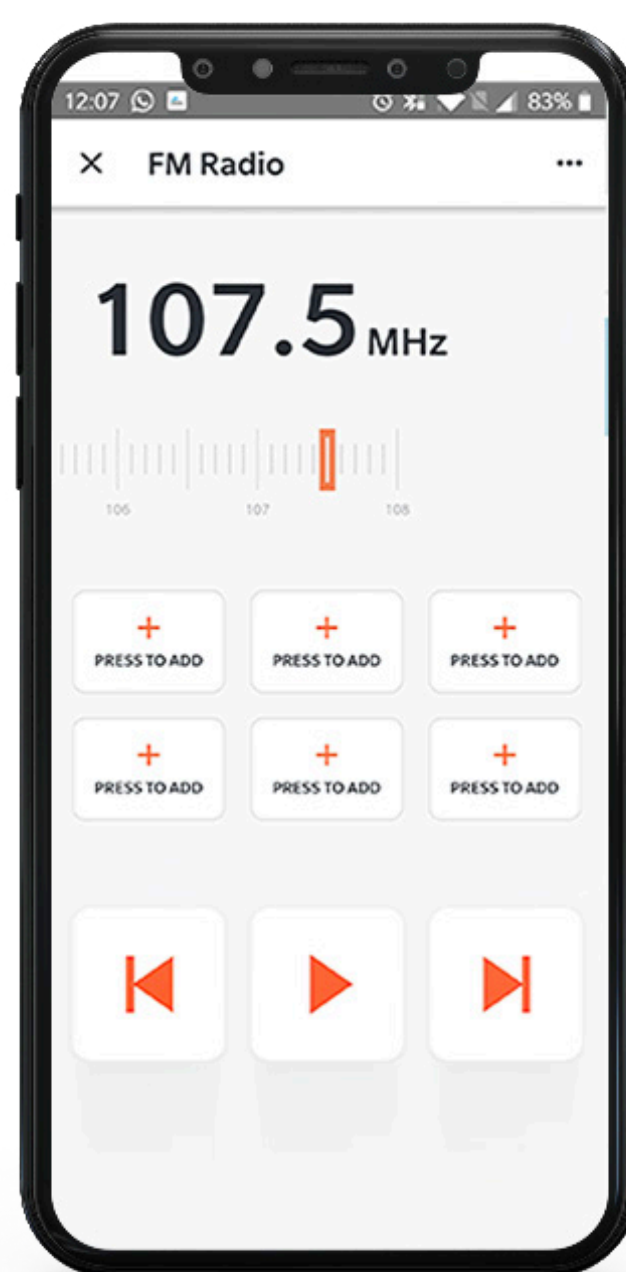

Starten met scannen

x3
tikken

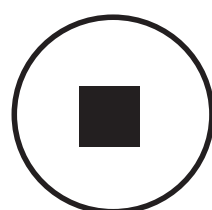
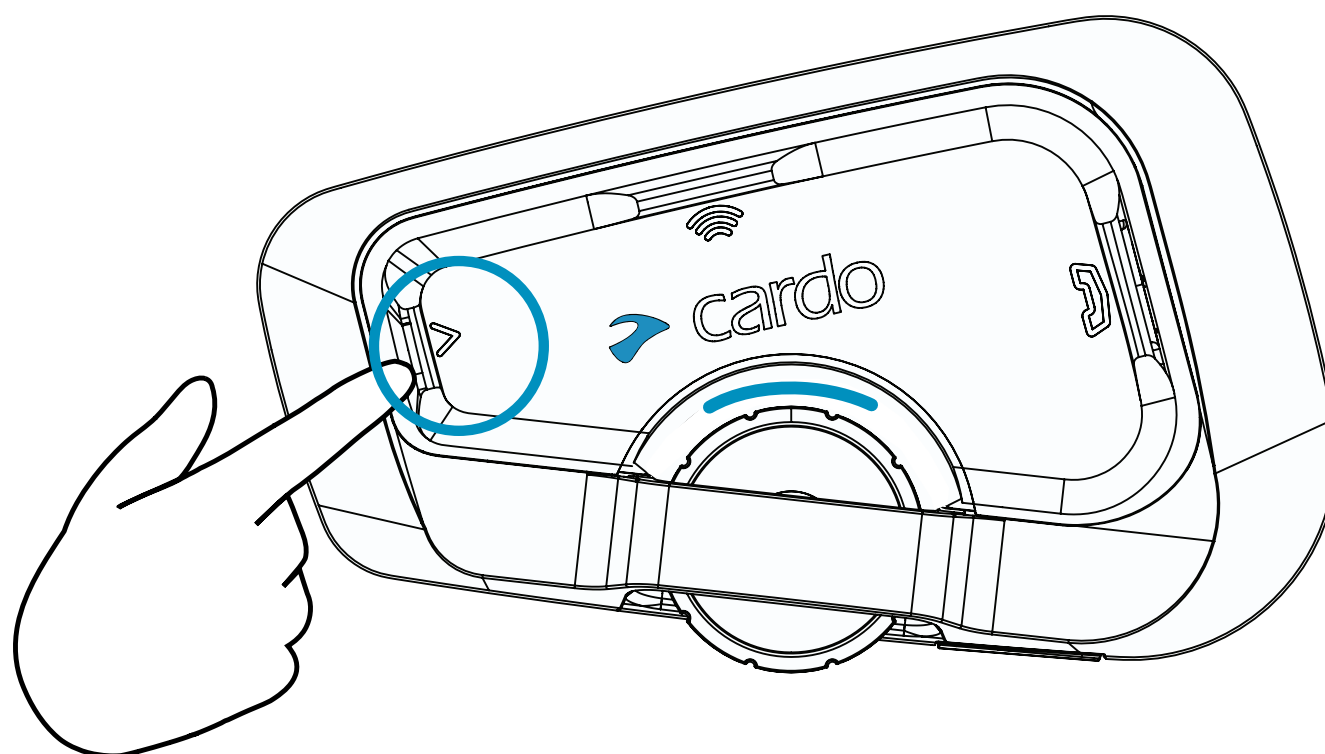

Stoppen met scannen

x1
tikken

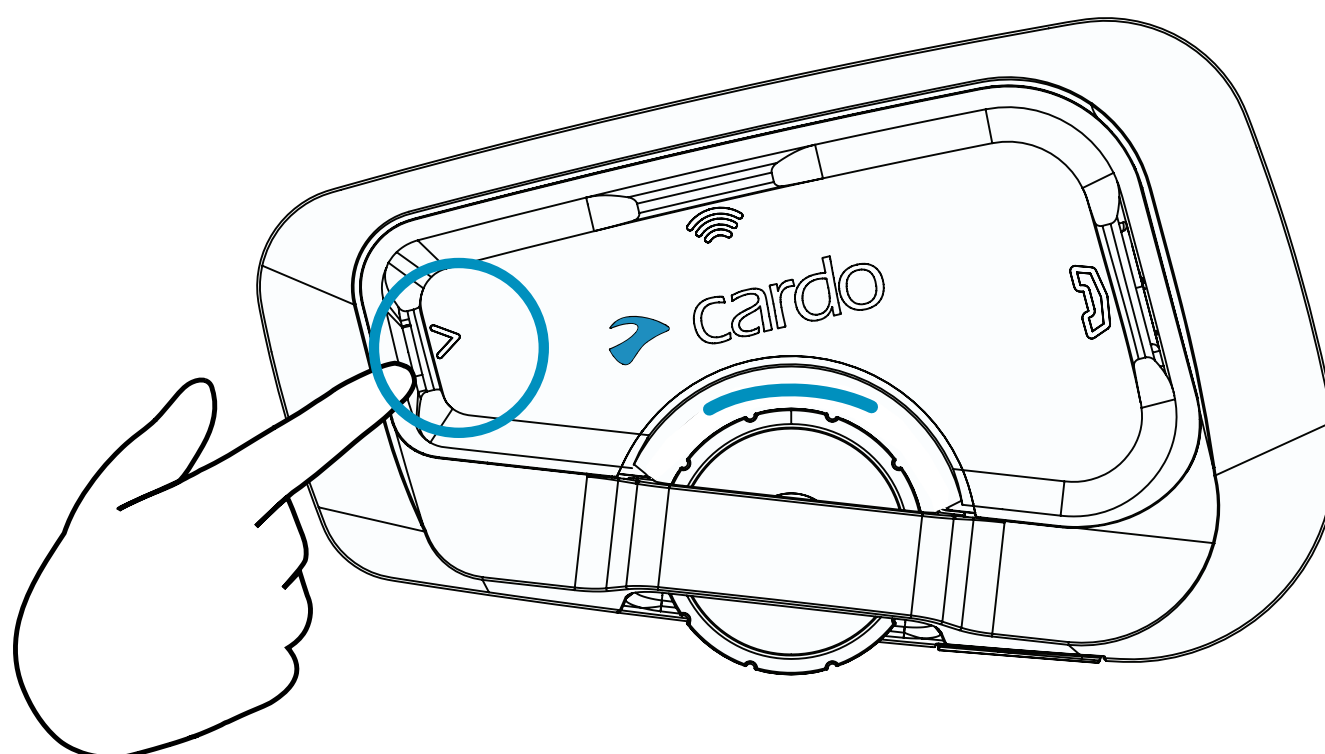

Radio



Aan

x2
tikken

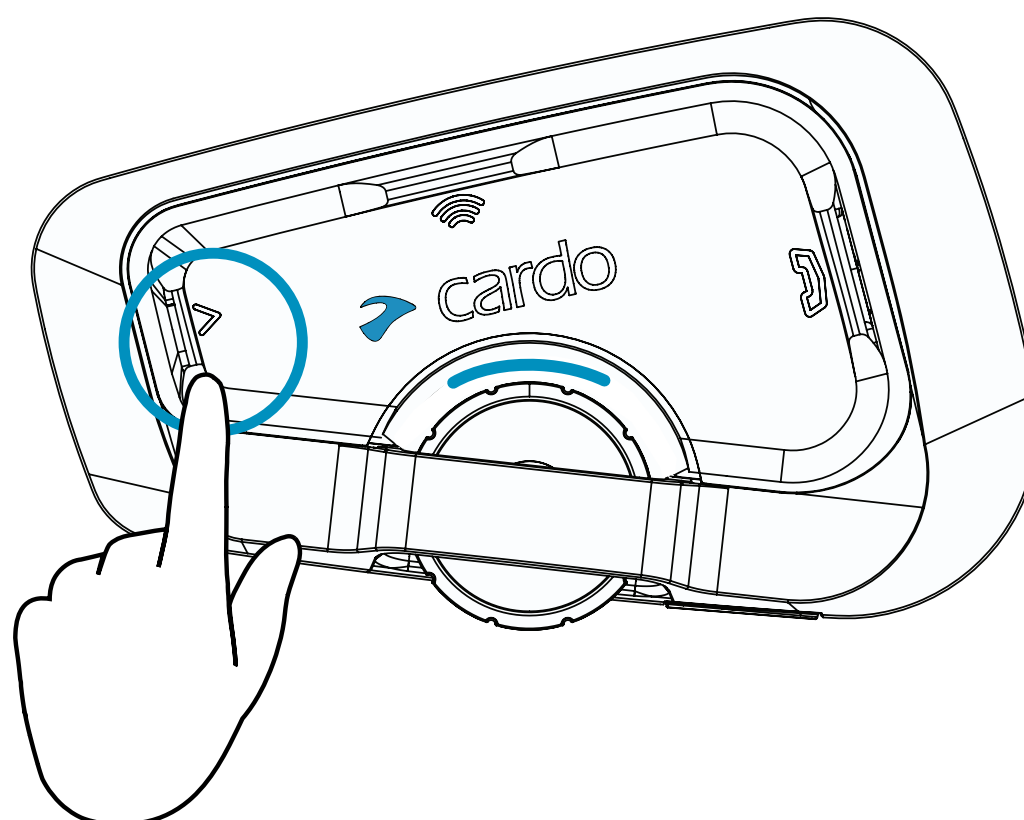

Uit

x1
tikken

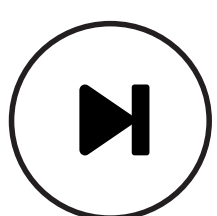
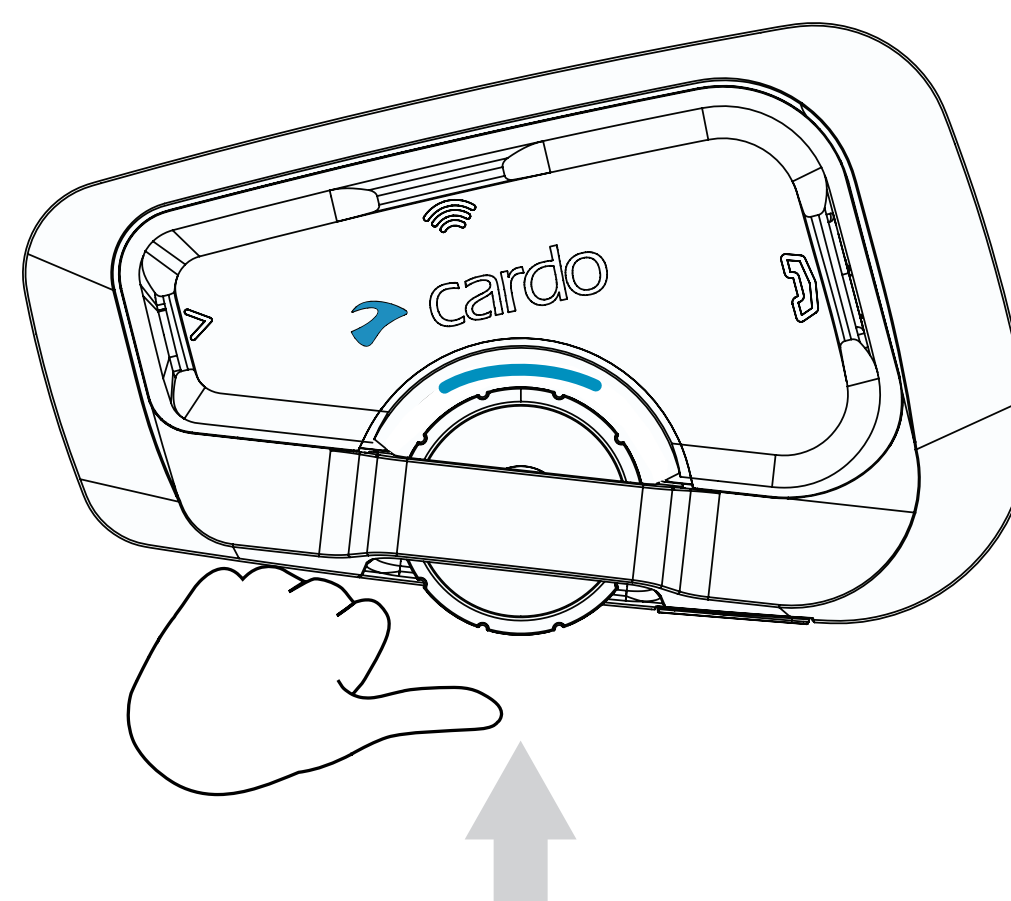

Volgende voorkeuzezender

x1
tikken

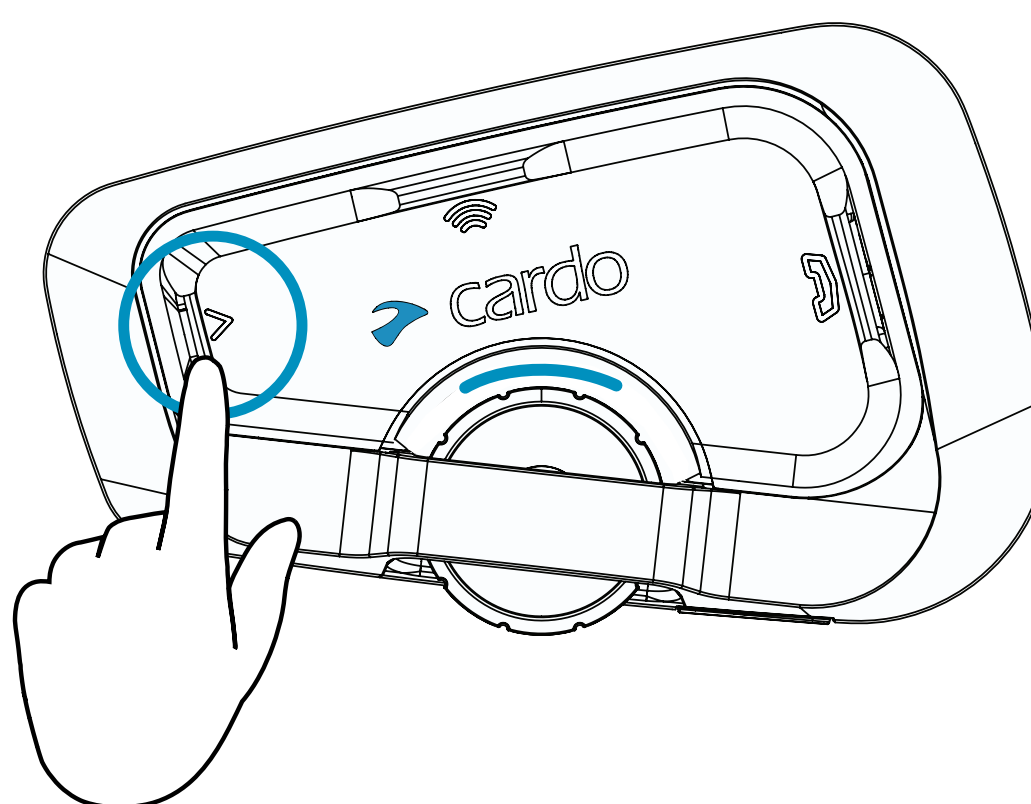

Vorige voorkeuzezender

x2
tikken

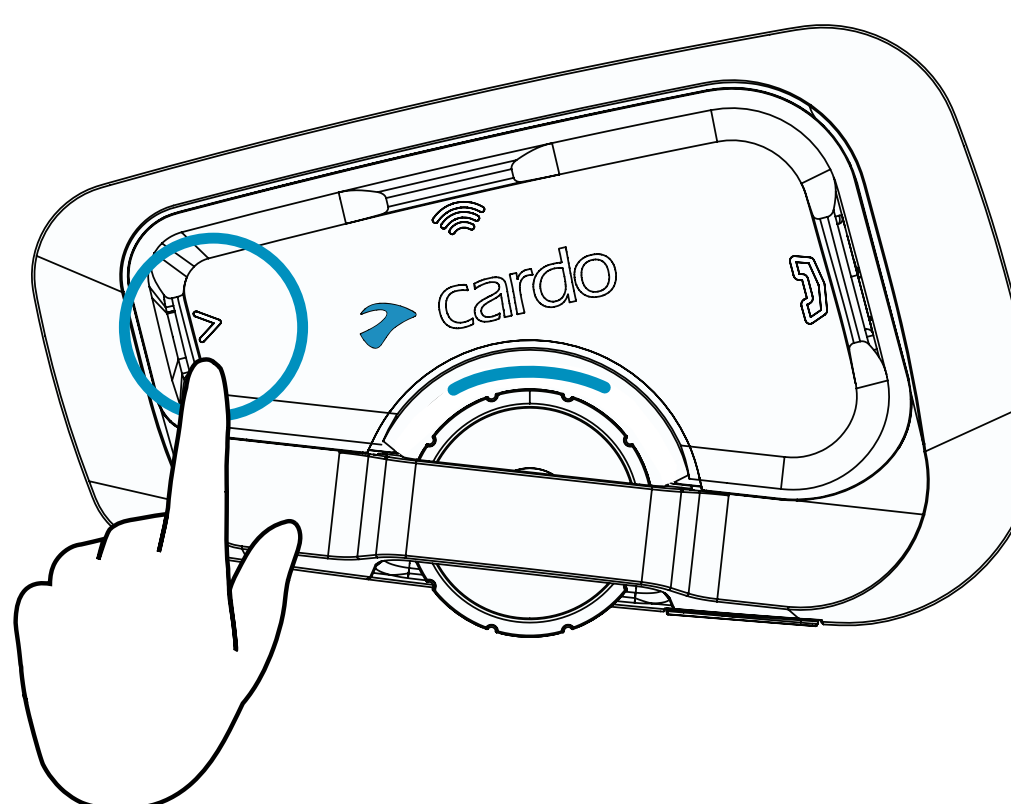

Bron wisselen



Muziek naar radio

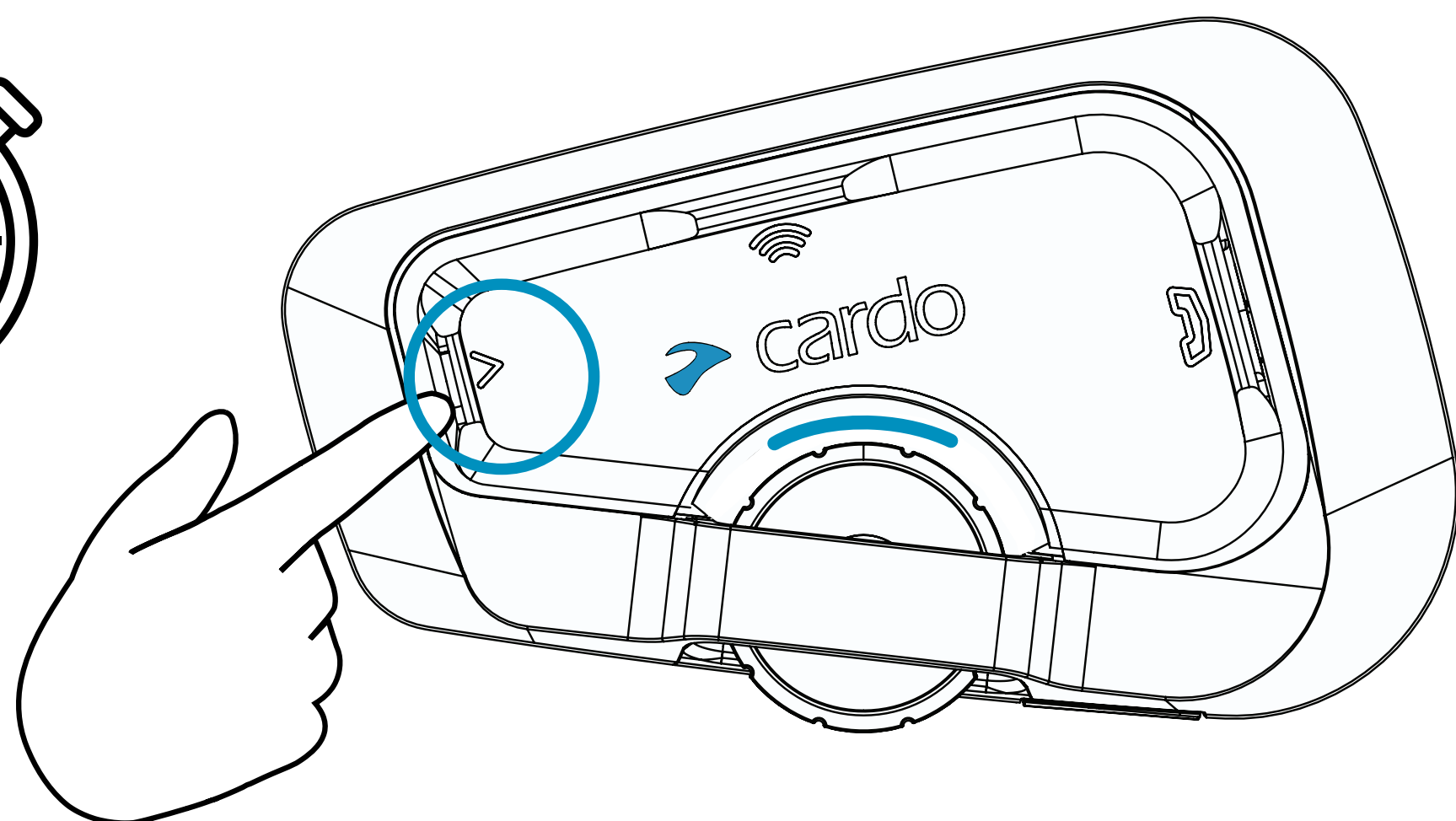

Radio naar muziek

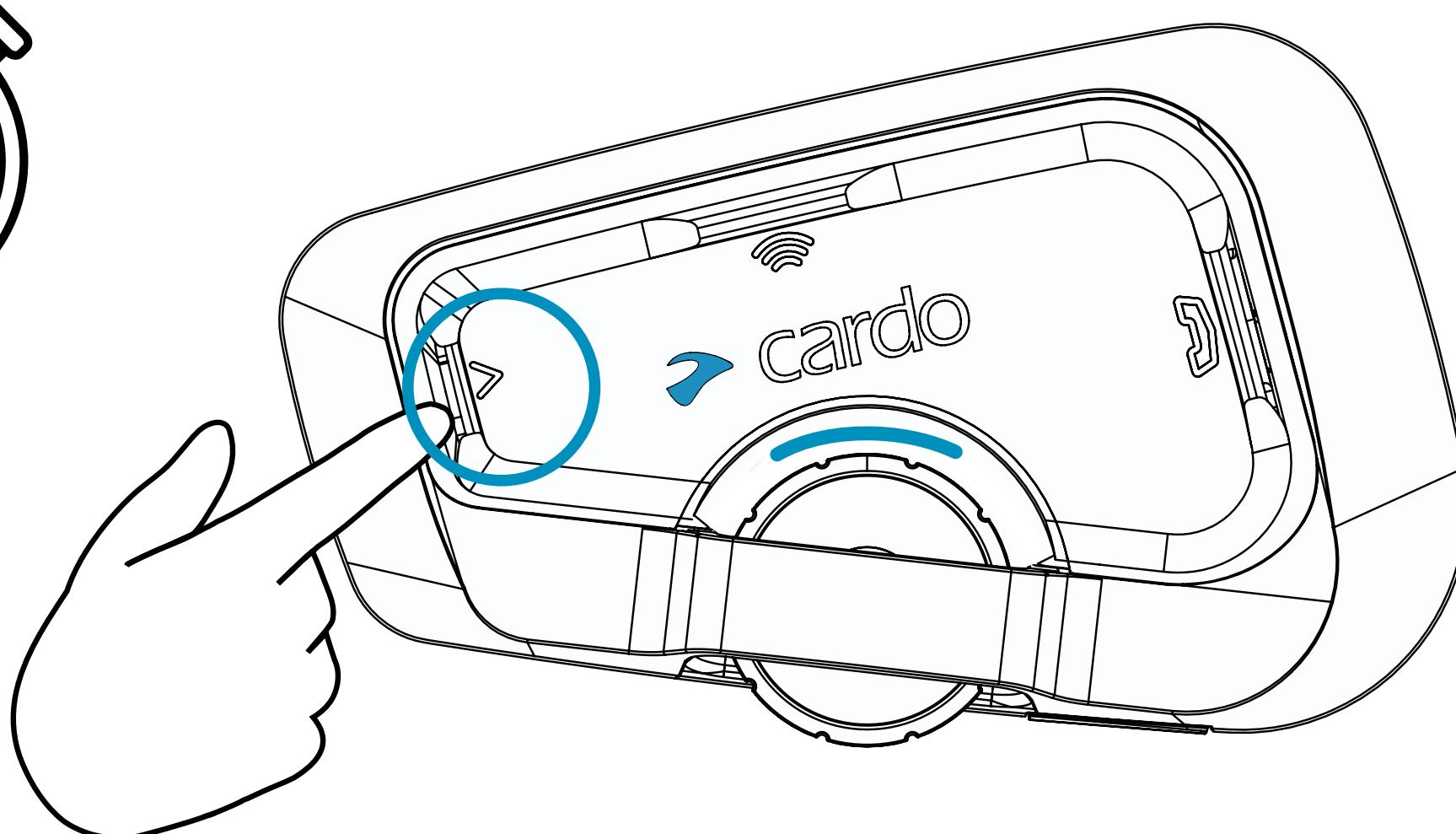

Telefoongesprek



Opnemen

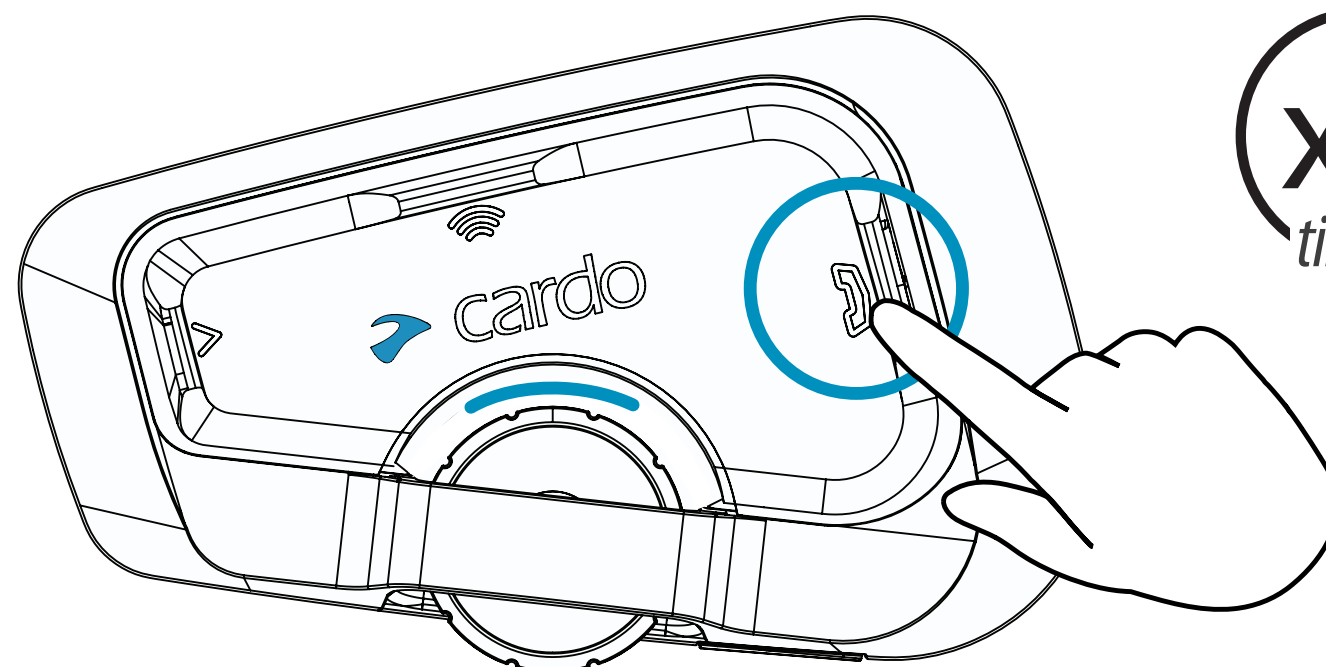

x1
tikken



Negeren

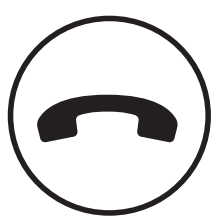
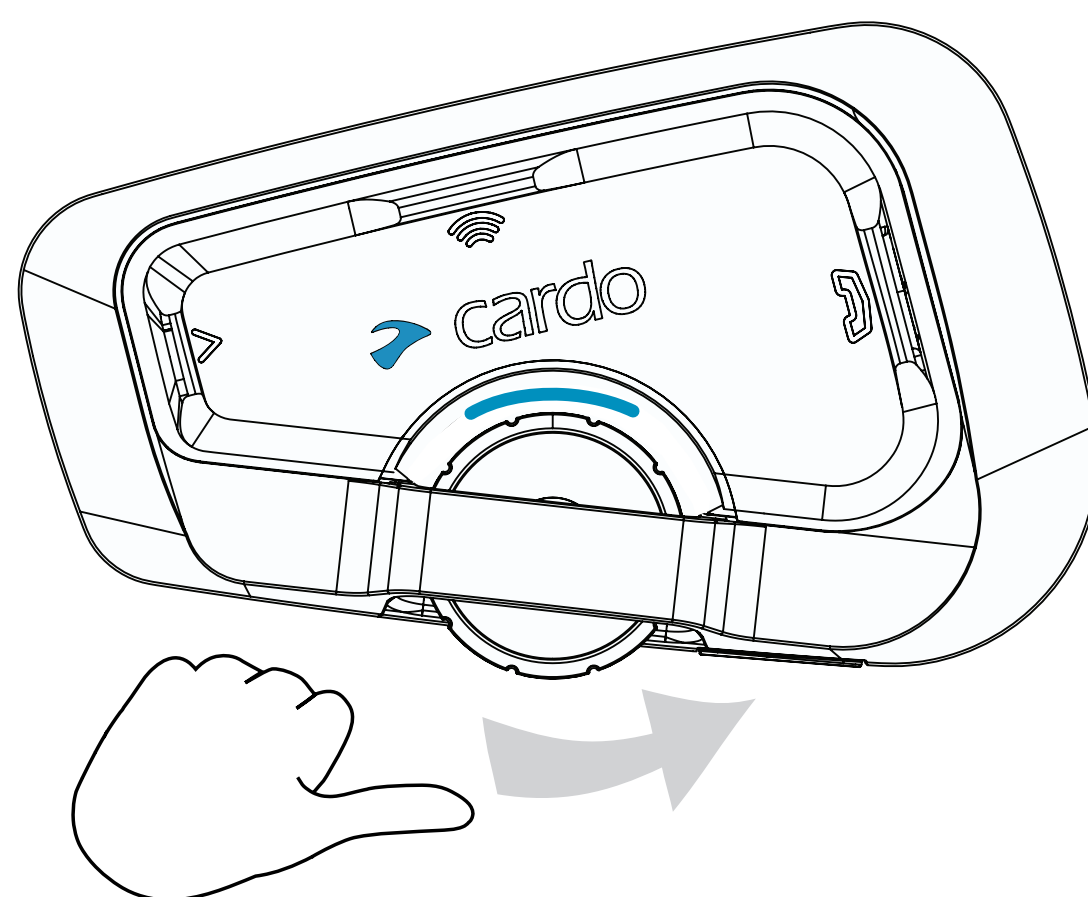

Gesprek beëindigen

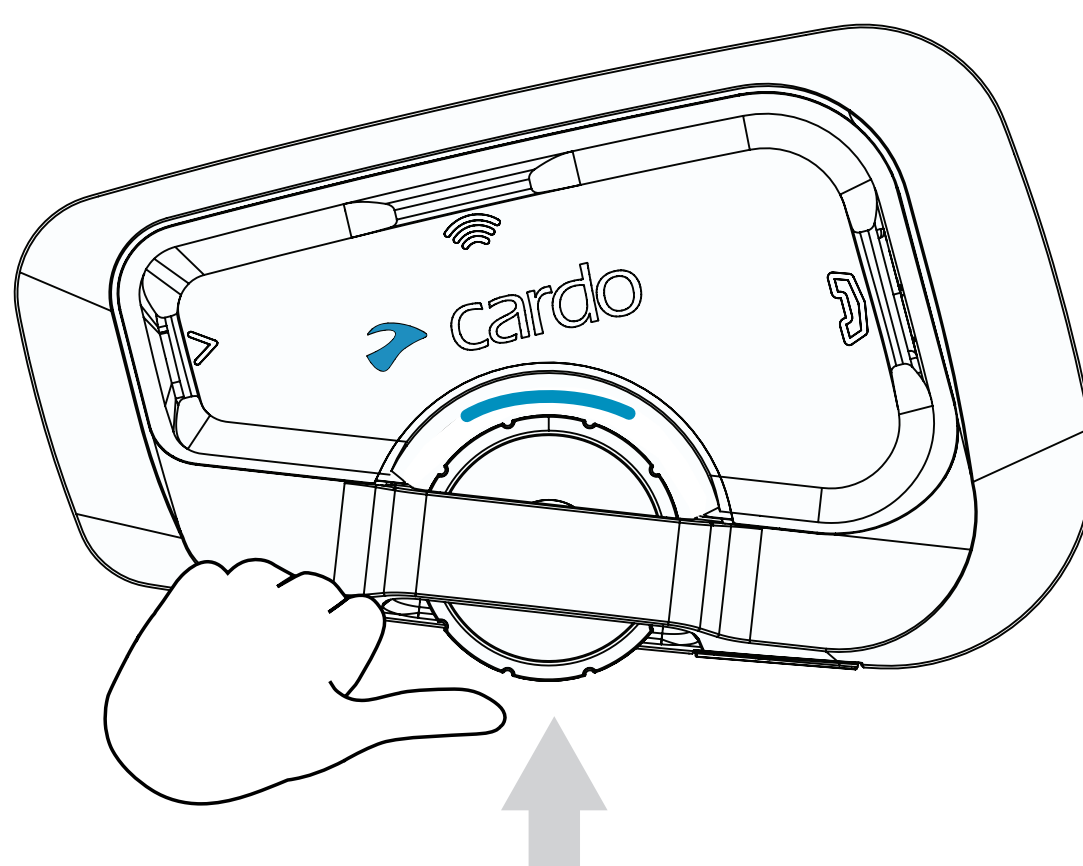

x1
tikken



Nummer herhalen

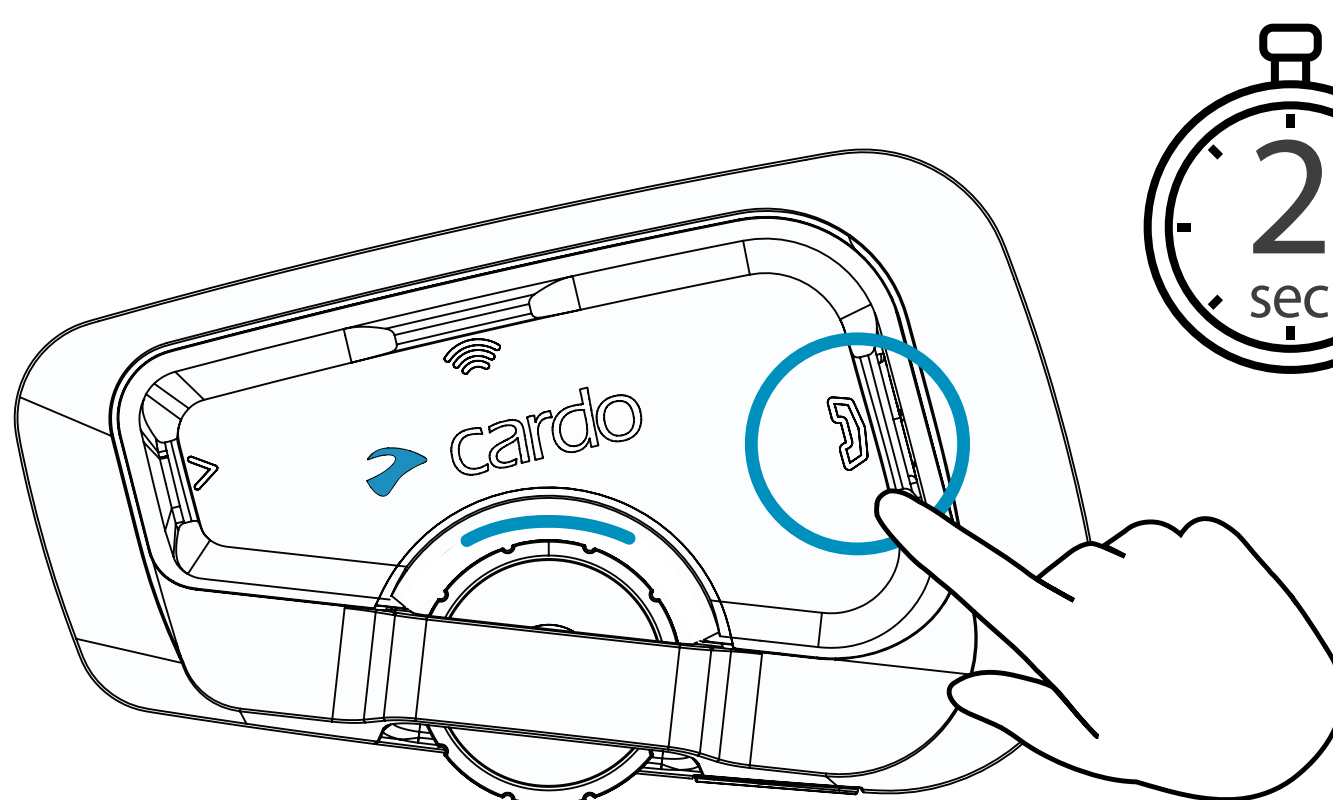

2
sec

Telefoongesprek



Snelkiesnummers

Nummer instellen

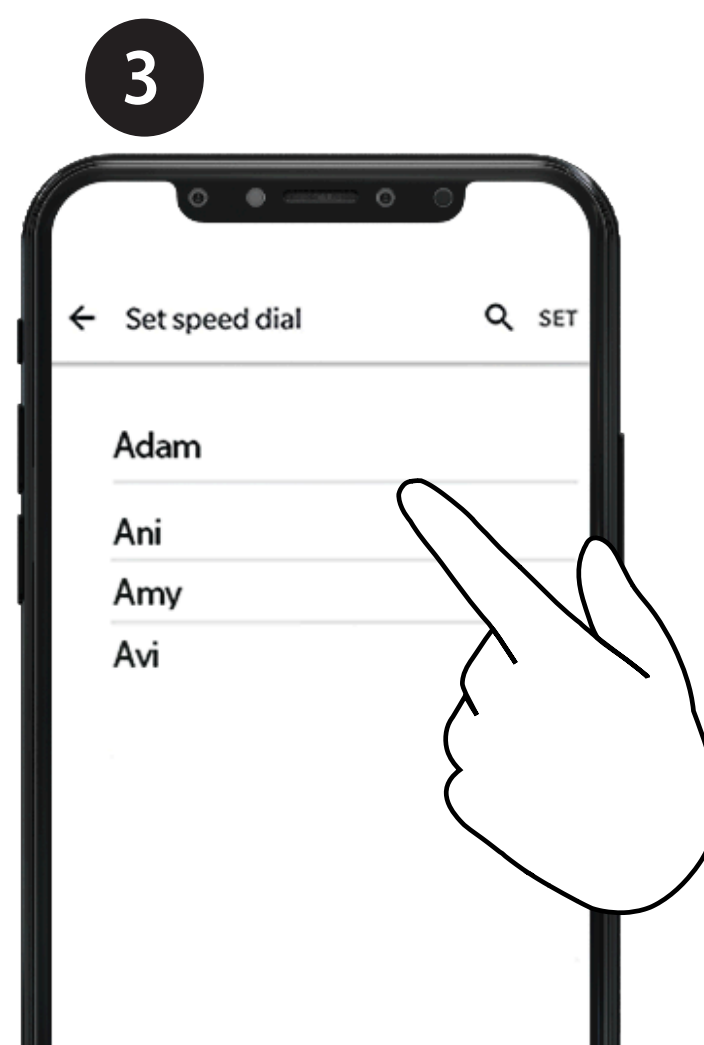
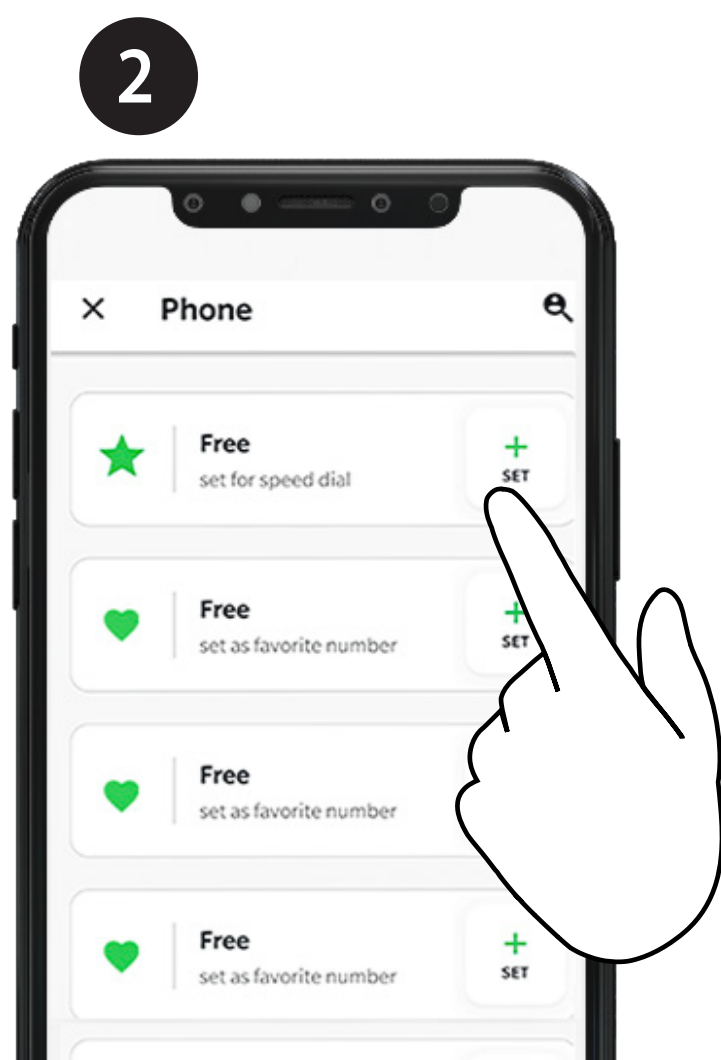
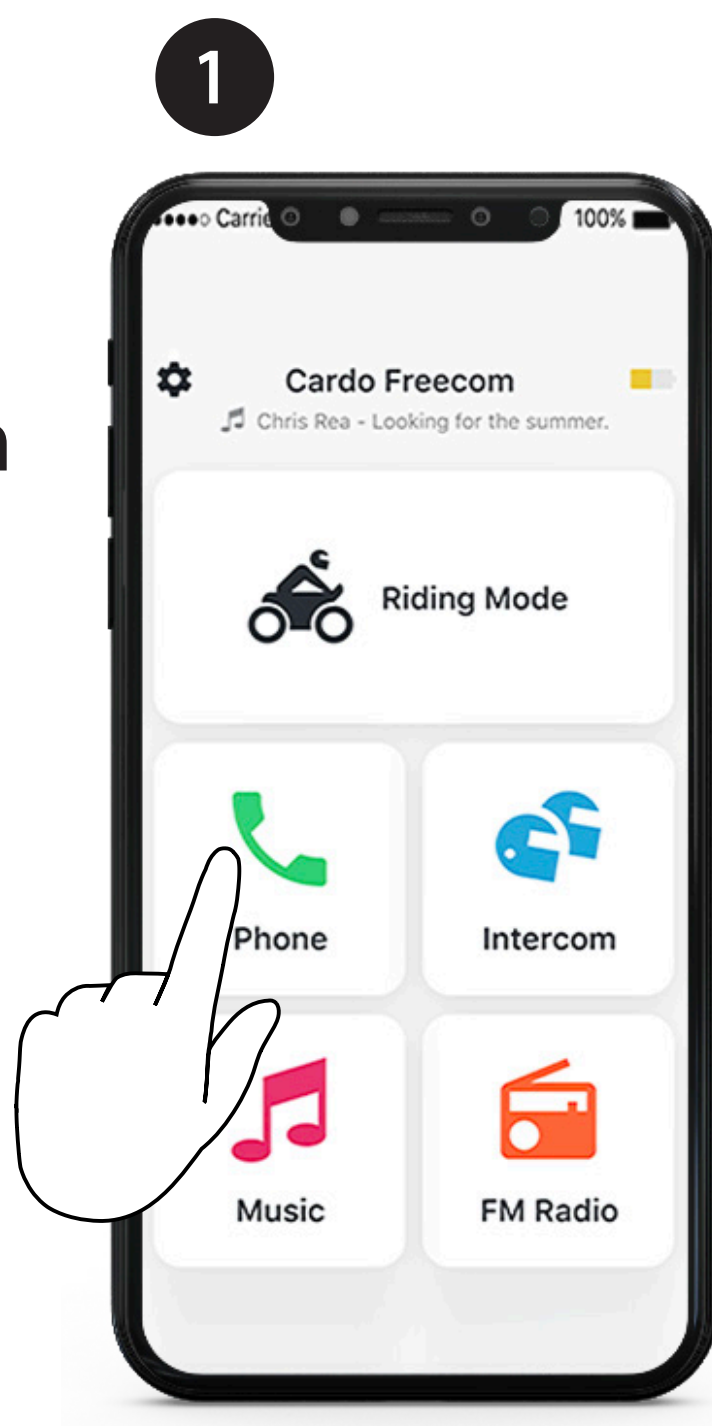

Snelkiesnummer bellen

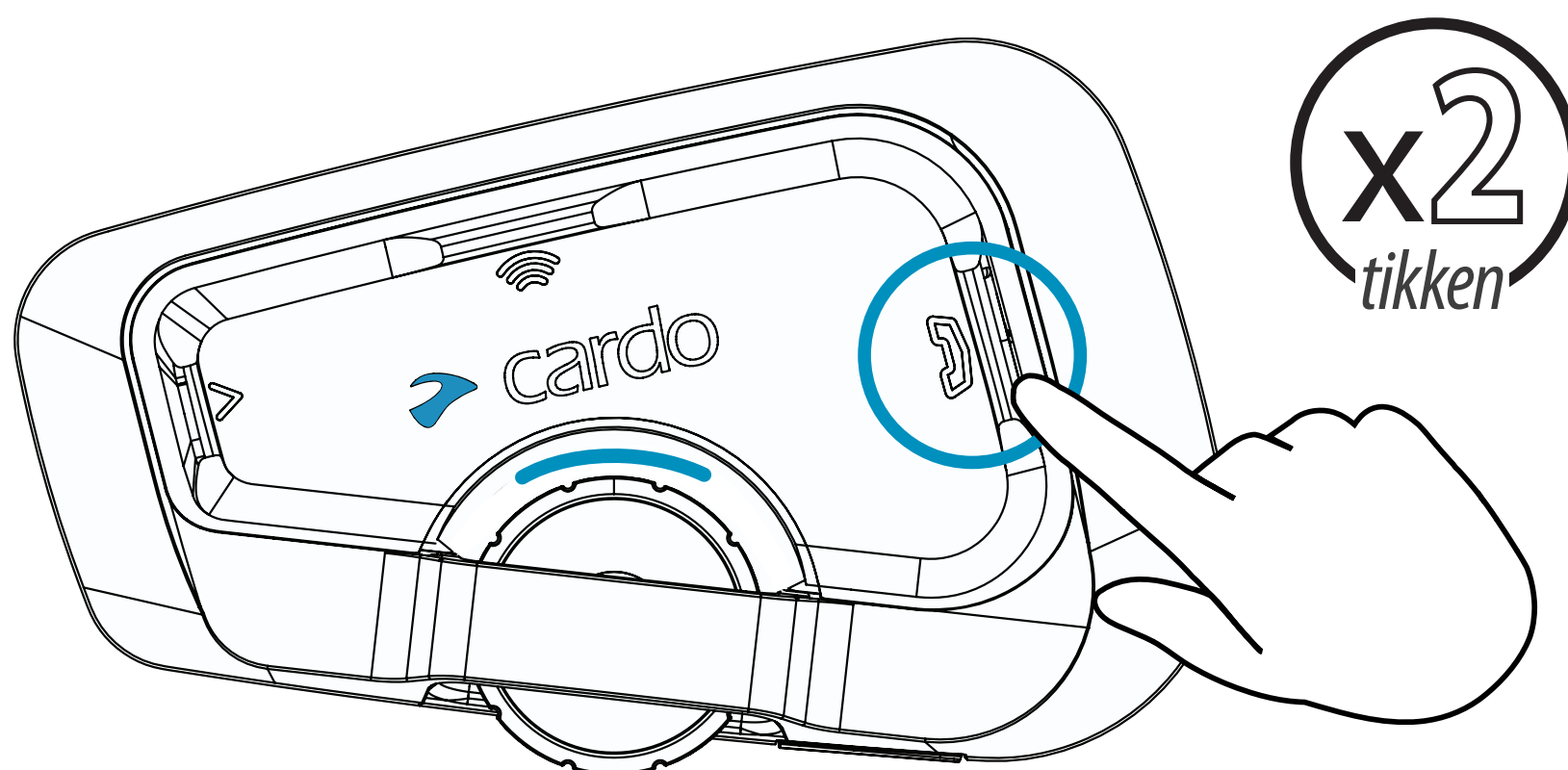

Bluetooth-intercom

Koppelen

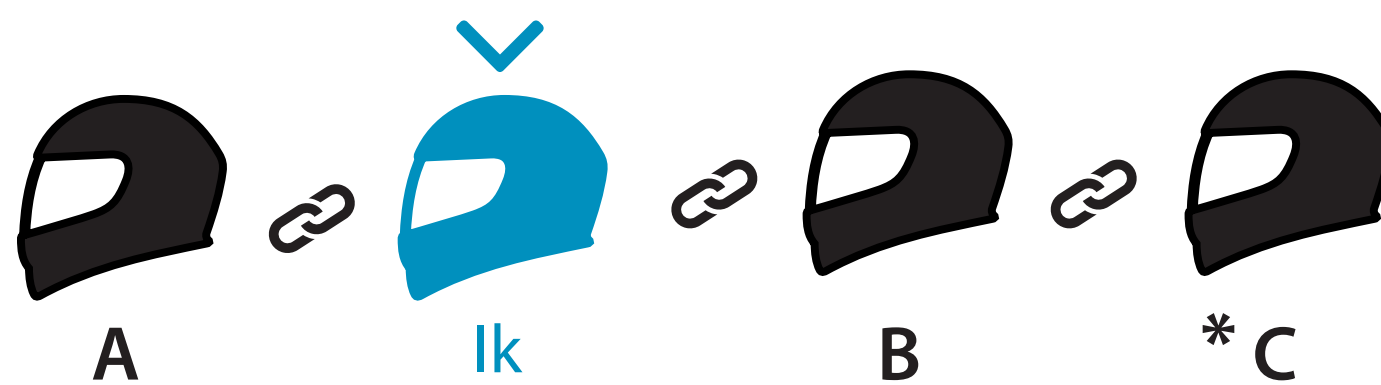

Koppelen met motorrijder A

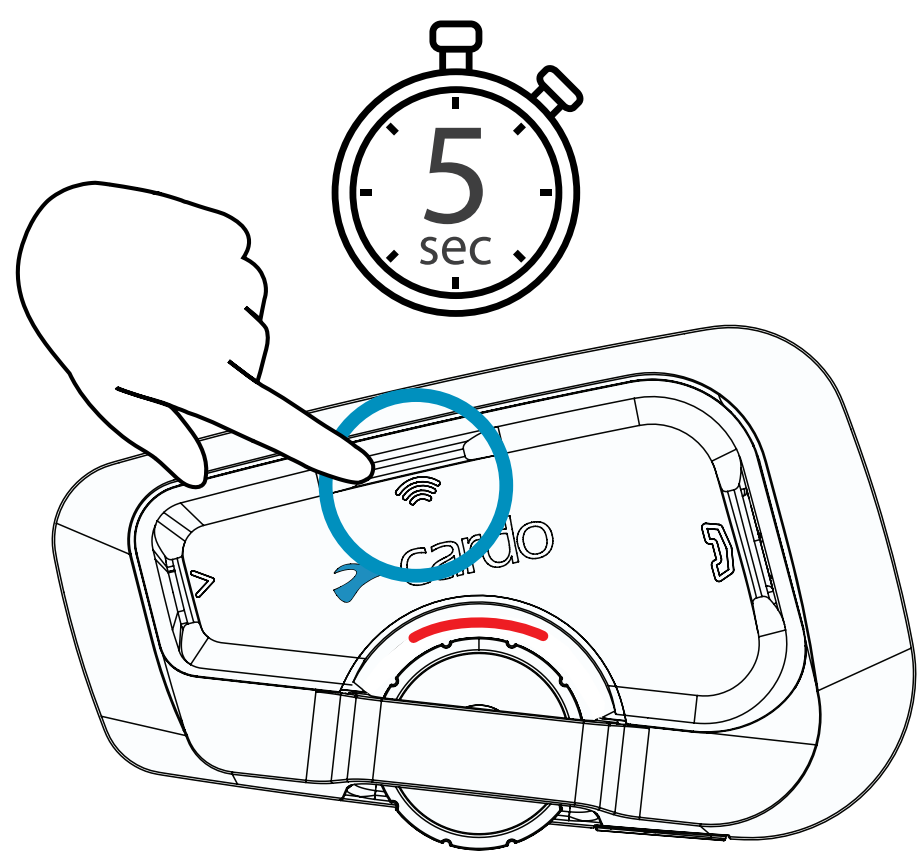

Led rood



Koppelen met motorrijder B

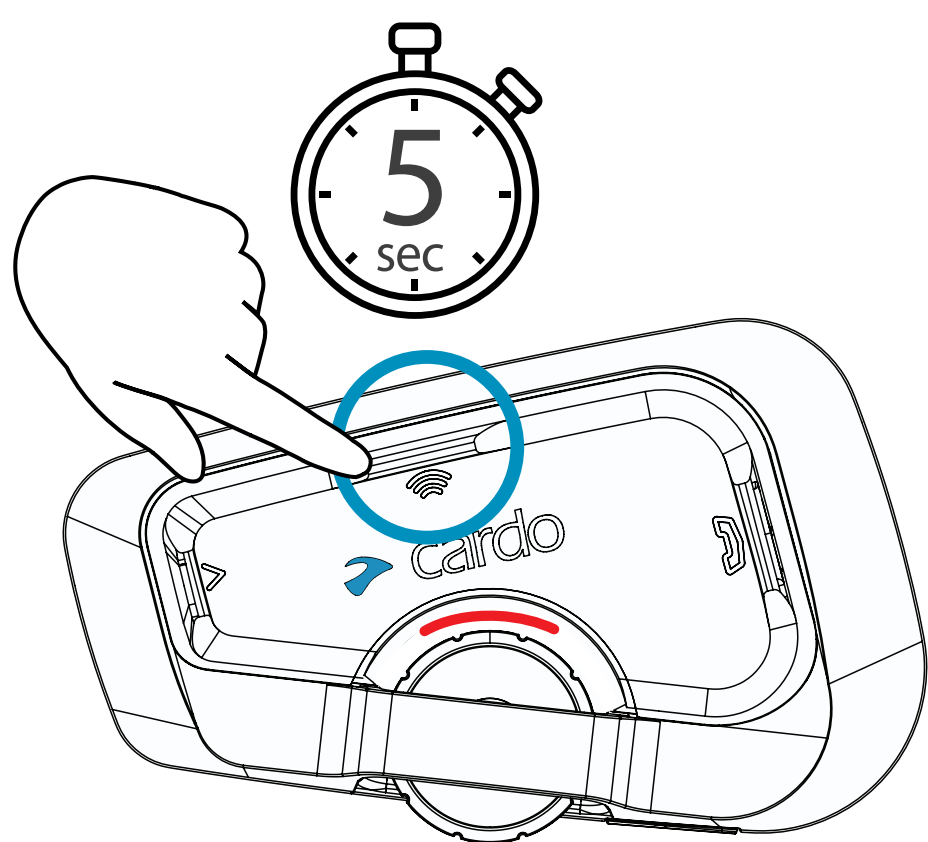

Led rood

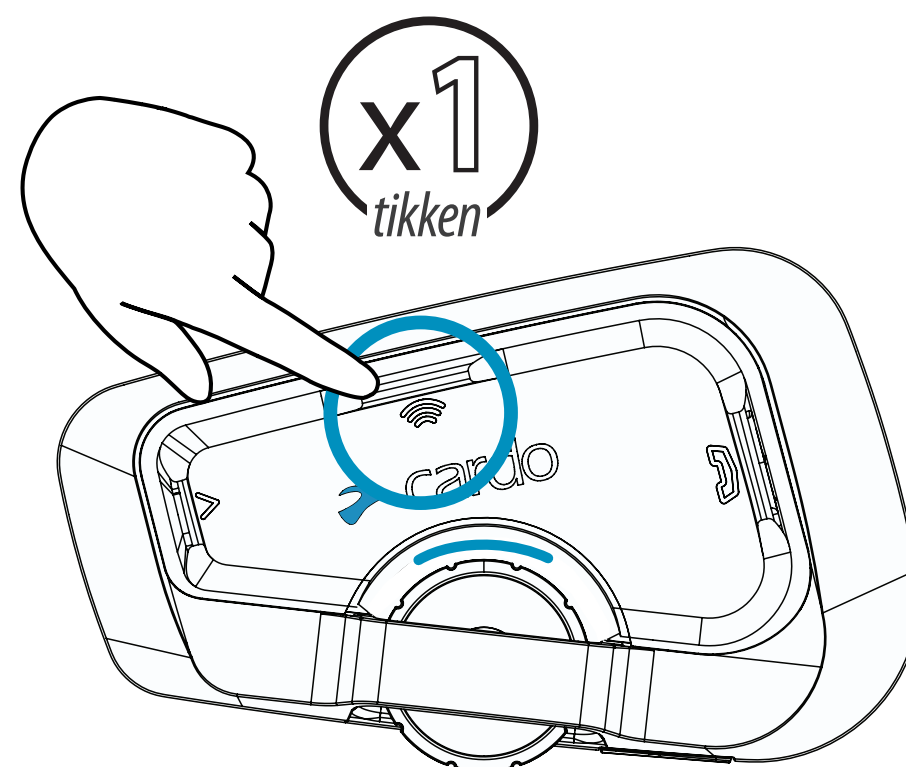

Led blauw



* Motorrijder C moet verbonden zijn met motorrijder B

Bluetooth-intercom



Bellen via intercom/gesprek beëindigen

Motorrijder A

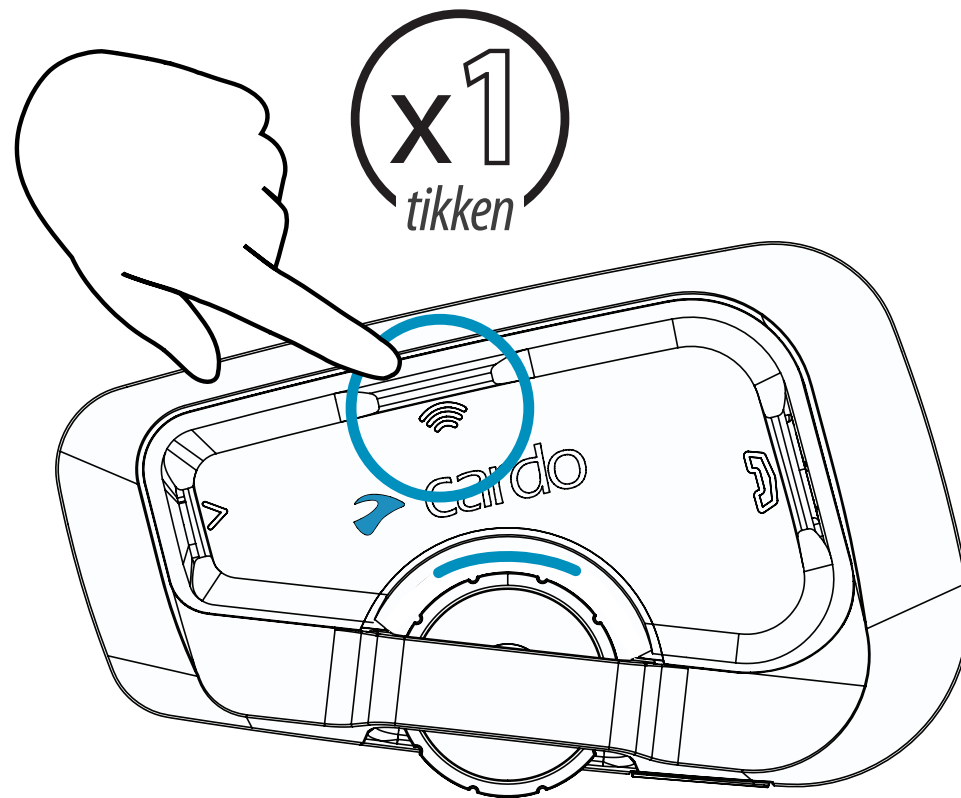

Motorrijder B

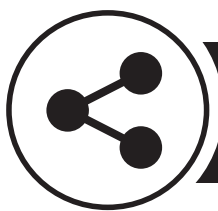
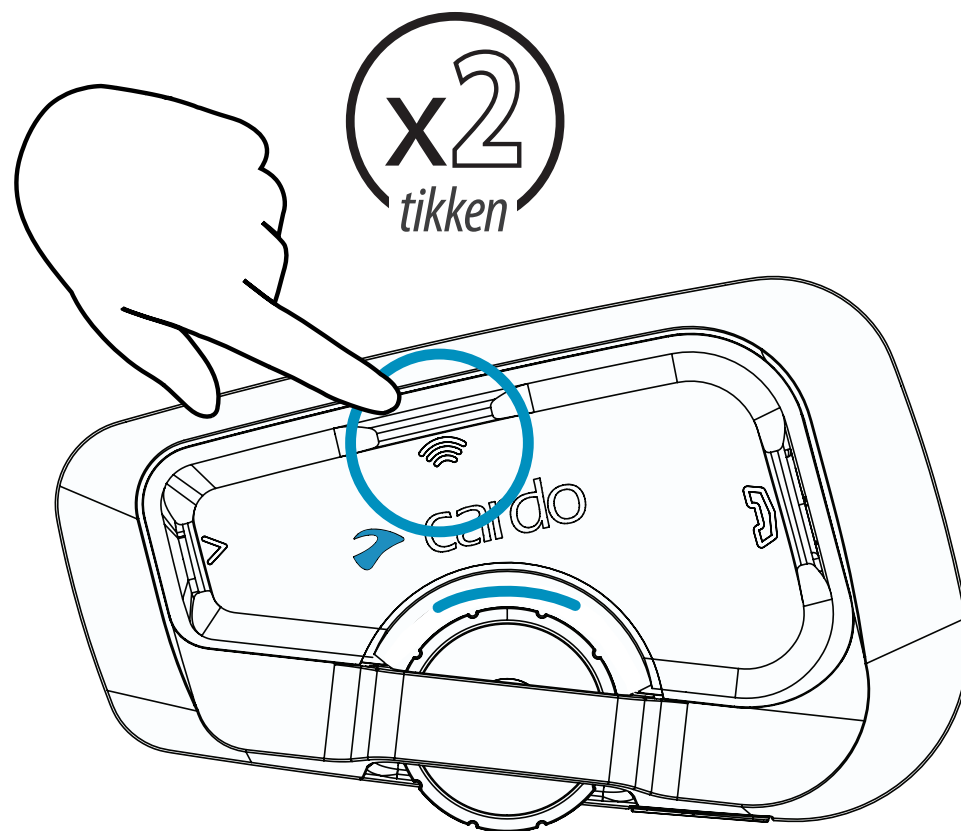

Delen



Muziek delen

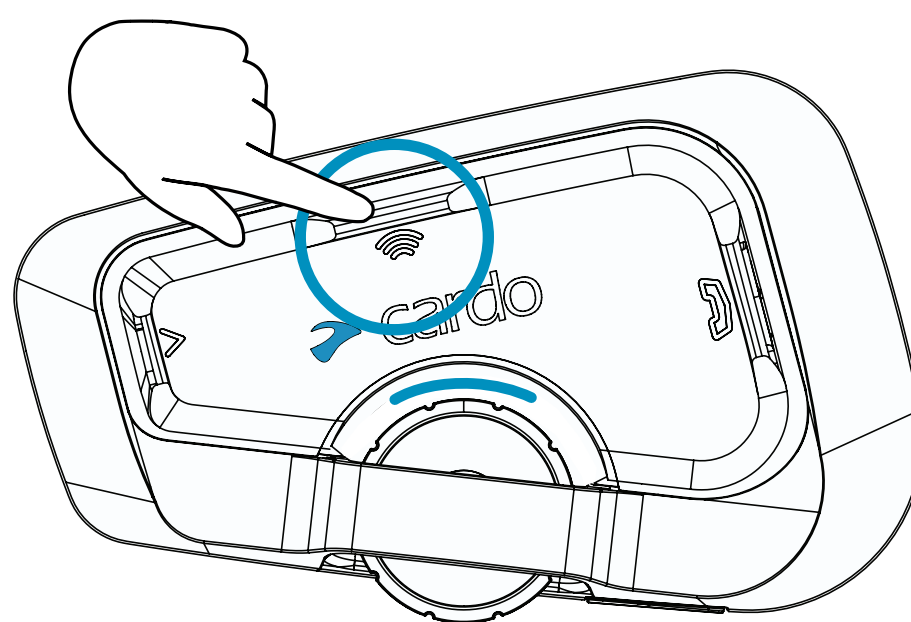

Telefoongesprek delen

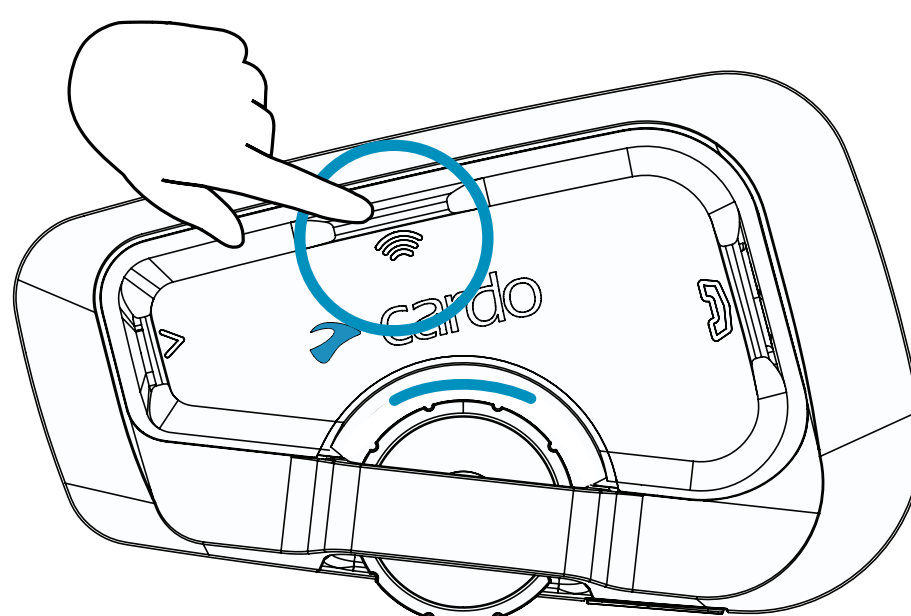

GPS koppelen

1 Stap 1

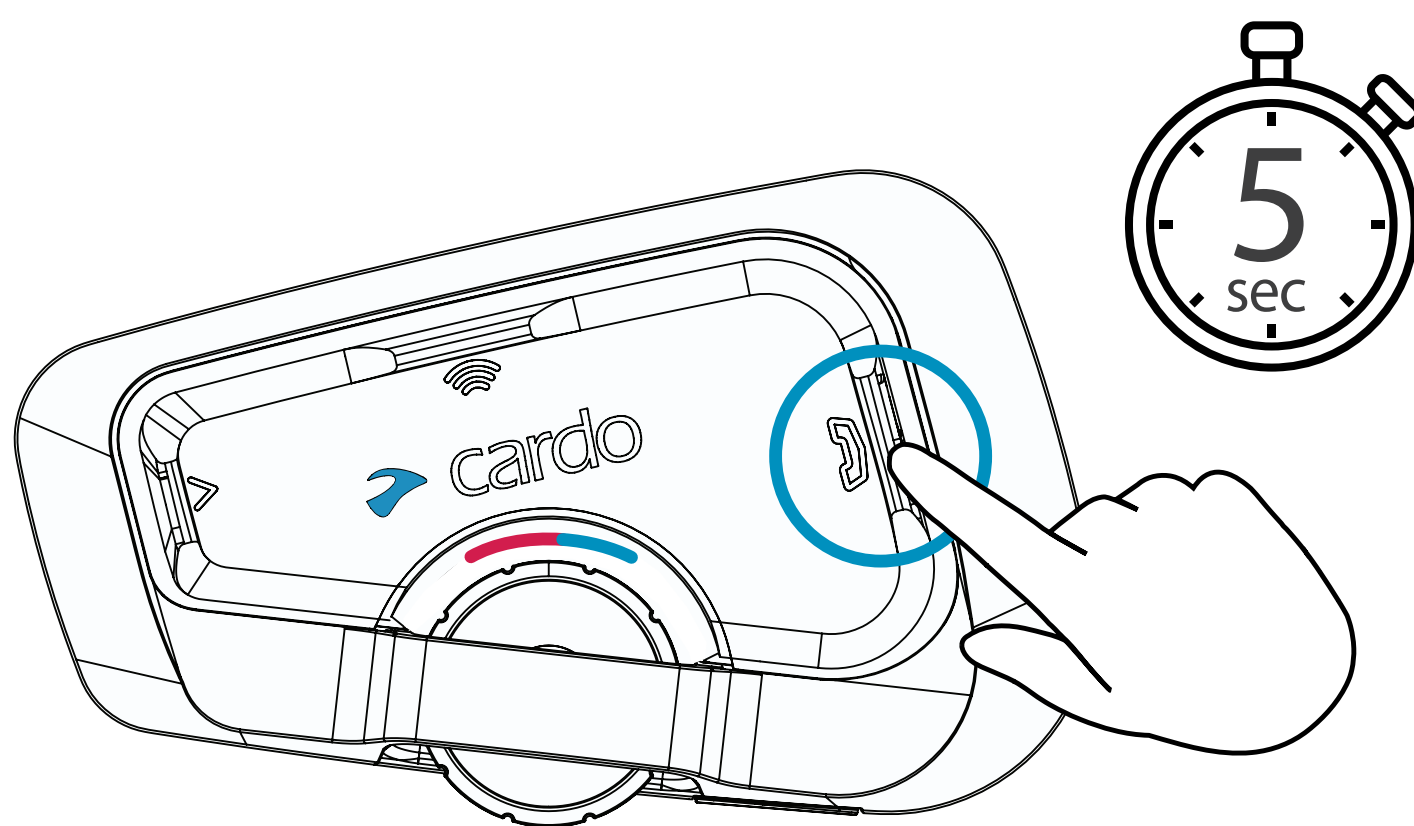

Led rood en blauw



2 Stap 2

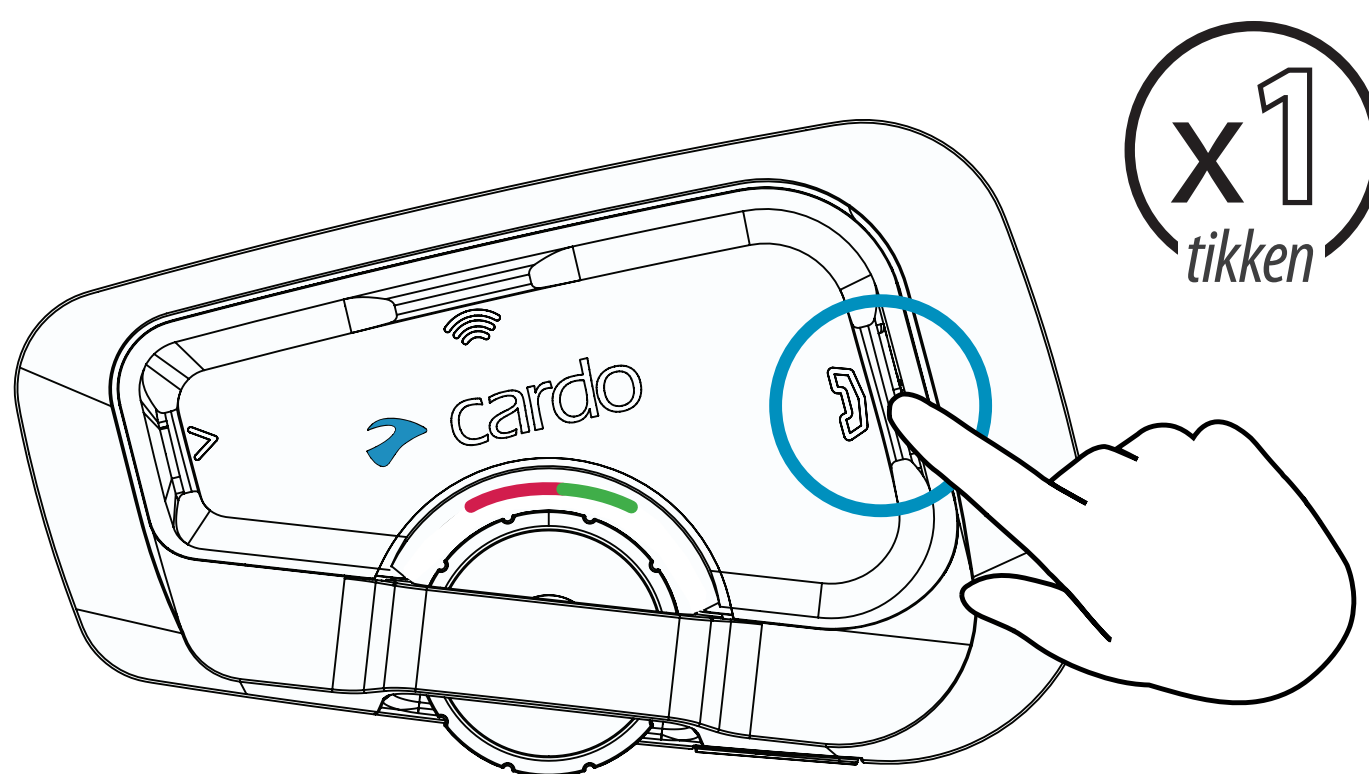

Led rood en groen



3 Stap 3



Spraakopdrachten - *Altijd aan!*



- **Answer**
- **Ignore**
- "Hey Cardo, **end call**"
- "Hey Cardo, **speed dial**"
- "Hey Cardo, **redial number**"



- "Hey Cardo, **music on**"
- "Hey Cardo, **music off**"
- "Hey Cardo, **next track**"
- "Hey Cardo, **previous track**"
- "Hey Cardo, **share music**"



- "Hey Cardo, **radio on**"
- "Hey Cardo, **radio off**"
- "Hey Cardo, **next station**"
- "Hey Cardo, **previous station**"



- "Hey Cardo, **call intercom**"
- "Hey Cardo, **end intercom**"



- **"Hey Siri"**
- **"OK Google"**



- "Hey Cardo, **volume up**"
- "Hey Cardo, **volume down**"
- "Hey Cardo, **mute audio**"
- "Hey Cardo, **unmute audio**"

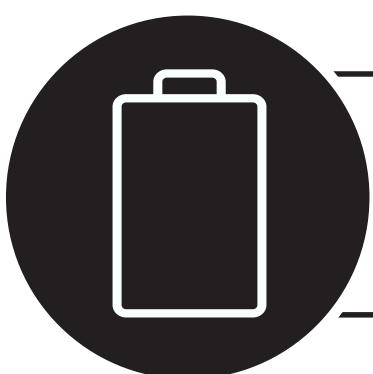

- "Hey Cardo, **battery status**"

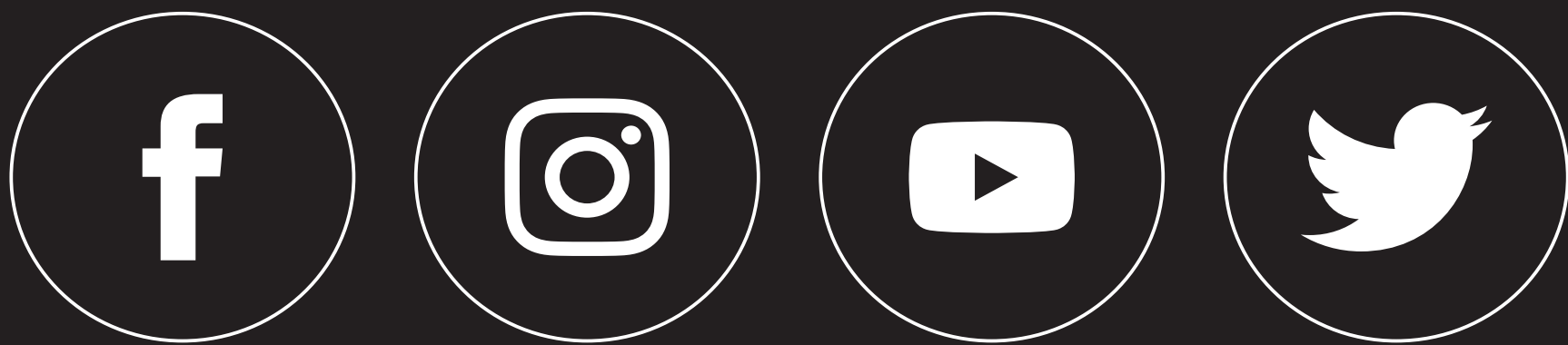

Cardosystems.com

Cardosystems.com/update

Cardosystems.com/support