



LAZER

VeloVox

.....
POCKET GUIDE

[EN](#)|[NL](#)|[TW](#)|[PL](#)|[CZ](#)|[SV](#)|[NOR](#)|[DK](#)|[FIN](#)|[GR](#)|[RO](#)|[BG](#)|[HU](#)|[SLO](#)|[SK](#)|[LV](#)|[LT](#)|[ET](#)|[HE](#)

Table of Contents

English	1
Dutch	17
Taiwanese	32
Polish	47
Czech	62
Swedish	77
Norwegian	92
Danish	107
Finnish	122
Greek	137
Romanian	152
Bulgarian	167
Hungarian	182
Slovakian	212
Estonian	227
Lithuanian	242
Latvian	257
Hebrew	272

cardo CONNECT APP

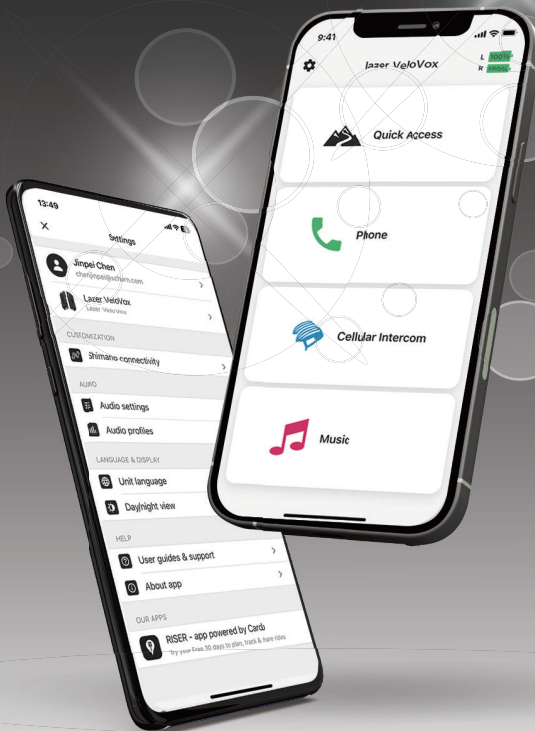

Cardo
Connect App
for Lazer



Table of Contents

4-5

Getting Started

6

Cardo Connect App

7

General

8

Music

9

Phone Call

10

Cellular Intercom

11

Factory Reset & Reboot

Advanced Features

12

Shimano Connectivity

13

Default settings

14

Customizing Shimano Connectivity

Getting Started

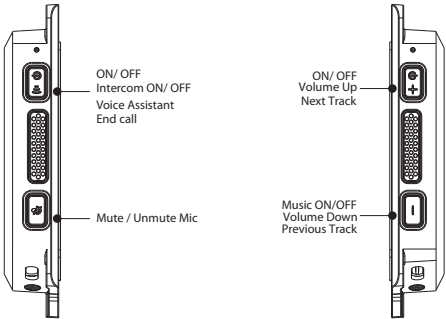
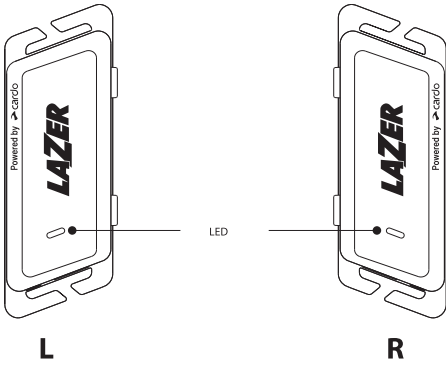



On

First time: automatic pairing ON



L



R



Off



L



R



If needed: start new pairing



R



LED Red & Blue





Download



Register

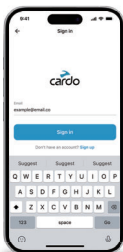

Choose Language

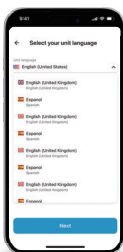

Update Software



General

Volume Up



Volume Down



Voice Assistant



▶ On



X2
Tap

⏸ Off



X2
Tap

▶▶ Next Track



X2
Tap

◀◀ Previous Track



X3
Tap

Phone Call



Answer

Press any button to answer the phone call

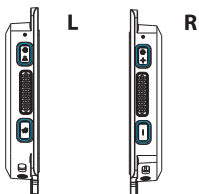

End Call



Cellular Intercom



Intercom grouping



Cardo
Connect App
for Lazer



Intercom ON/OFF



Mute Microphone



Unmute Microphone



Factory Reset & Reboot



Factory Reset

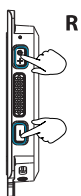

Reboot

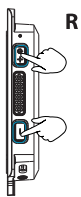

Reset audio unit



Reset communication unit

Advanced Features

Shimano Connectivity

Shimano Pairing



- 1) Update your Di2 firmware.
- 2) Set button(s) on Shimano Di2 shifters to a D-Fly channel with the Shimano E-Tube App.
- 3) Press any button on shifter for pairing.



- 1) Update your firmware.
- 2) Set button(s) on Shimano EBIKE systems to a D-Fly channel with the Shimano E-Tube App.
- 3) Switch on the bike for pairing.

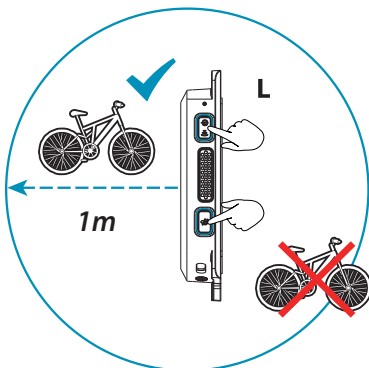

1. Do not pair when other bike is around
2. Put your bike not further than 1 m



LED Red & Blue





Overview of default settings

9:41



Shimano connectivity

D-FLY channel 1

Short press:

Mic mute / unmute

Double press:

Cycling information

Long press:

Voice assistance

D-FLY channel 2

Short press:

Unable/ disable group co...

Double press:

Music on / off

Long press:

Answer / end call

D-FLY channel 3

Short press:

Volume up

Double press:

Next track

Long press:

+ Add action

D-FLY channel 4

Short press:

Volume down

Double press:

Previous track

Long press:

+ Add action

Customizing Shimano Connectivity



Open Settings menu

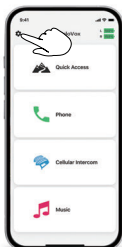

Open Shimano Connectivity

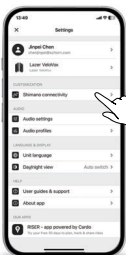

Change commands



www.lazersport.com

LAZER

Reach out and follow us:

 @Lazersport

 LazerHelmets

 info@lazersport.com



Cardo
Connect App
for Lazer

Cardosystems.com/update

Cardosystems.com/support



LAZER

VeloVox

.....
POCKETGIDS

Dutch

cardo CONNECT APP

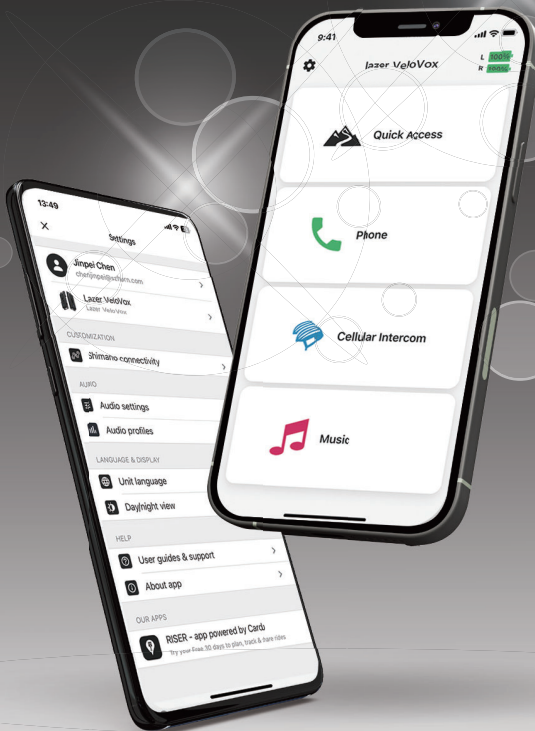

Cardo
Connect App
for Lazer



Inhoudsopgave

4-5

Aan de slag

6

Cardo Connect-app

7

Algemeen

8

Muziek

9

Telefoongesprek

10

Mobiele intercom

11

Fabrieksreset en herstart

Uitgebreide functies

12

Shimano-connectiviteit

13

Standaardinstellingen

14

Aanpassen van Shimano-connectiviteit

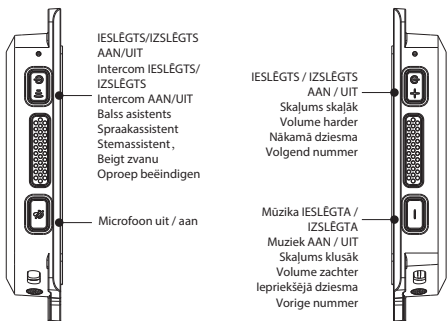
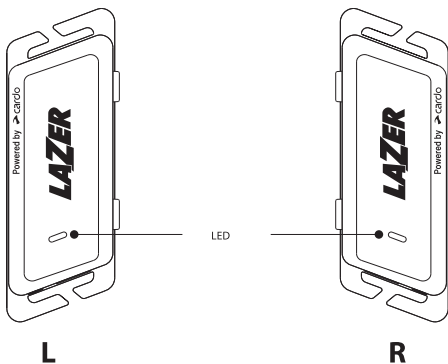

Druk en houd vast



Aantal aanrakingen

 AAN

Eerste keer: automatische
verbinding AAN



L



R

 UIT



L



R



 Indien nodig: start een nieuwe verbinding

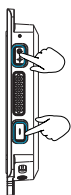

R



Rode en blauwe LED 





Downloaden



Downloaden vanuit de
App Store



Haal het uit de
Google Play



Registreren



Kies een taal

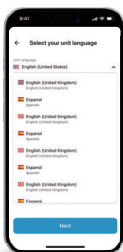

Software updaten



Volume verhogen



Volume verlagen



Stemassistent



 AAN



 X2
Tap

 UIT



 X2
Tap

 Volgend nummer



 X2
Tap

 Vorige nummer



 X3
Tap

Telefoonoproep



Antwoorden

Beantwoord de oproep door op een willekeurige knop te drukken

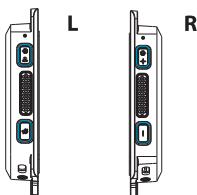

Oproep beëindigen



L

Mobiele intercom



Intercomgroeping

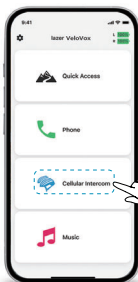

Cardo
Connect-app
voor Lazer



Intercom AAN / UIT



Microfoon uitschakelen



Microfoon inschakelen



Fabrieksreset en herstart



Fabrieksreset

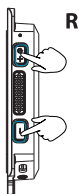

Herstart

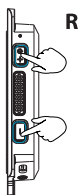

Reset audio-eenheid



Reset communicatie-eenheid

Uitgebreide functies

Geavanceerde functies

Shimano-verbinding

Di2
DIGITAL INTEGRATED INTELLIGENCE

- 1) Werk je Di2-firmware bij.
- 2) Stel de Shimano Di2 schakelaars voor het D-Fly-kanaal in met behulp van de Shimano E-Tube-app
- 3) Druk op een willekeurige schakelaarsknop om verbinding te maken



SHIMANO
E-BIKE
SYSTEMS

- 1) Werk je firmware bij.
- 2) Stel de knoppen van het Shimano EBIKE-systeem in voor het D-Fly-kanaal met behulp van de Shimano E-Tube-app.
- 3) Fiets aanzetten om te verbinden.

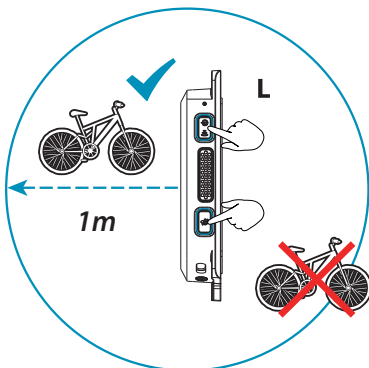

1. Maak geen verbinding als er een andere fiets in de buurt is
2. Plaats je fiets niet verder dan 1 meter



LED Rood en Blauw





9:41



Shimano connectivity

D-FLY channel 1

Short press:

Mic mute / unmute

Double press:

Cycling information

Long press:

Voice assistance

D-FLY channel 2

Short press:

Unable/ disable group co...

Double press:

Music on / off

Long press:

Answer / end call

D-FLY channel 3

Short press:

Volume up

Double press:

Next track

Long press:

+ Add action

D-FLY channel 4

Short press:

Volume down

Double press:

Previous track

Long press:

+ Add action

Aanpassing van de Shimano-connectiviteit



Open het instellingenmenu

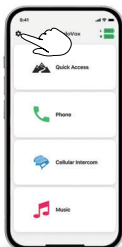

Open de Shimano-connectiviteit

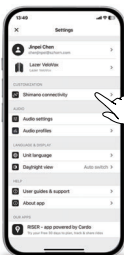

Opdrachten wijzigen



www.lazersport.com

LAZER

Reach out and follow us:

 @Lazersport

 LazerHelmets

 info@lazersport.com



Cardo
Connect App
for Lazer

Cardosystems.com/update

Cardosystems.com/support



LAZER

VeloVox

.....
袖珍指南
Taiwanese

cardo

CONNECT

APP

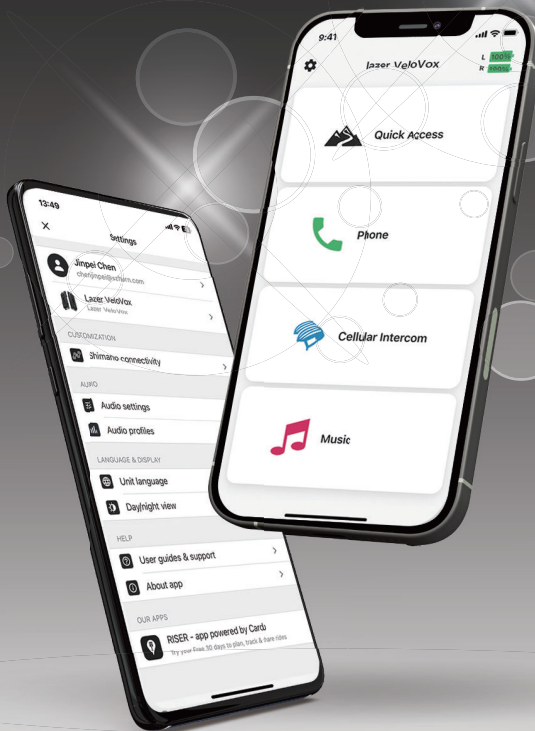

Cardo
Connect App
for Lazer



目錄

4-5

入門指南

6

Cardo 連線應用程式

7

總覽

8

音樂

9

電話通話

10

蜂巢對講機

11

恢復原廠設定與重新啟動

高級功能

12

禧瑪諾互聯

13

預設設定

14

自訂禧瑪諾互聯

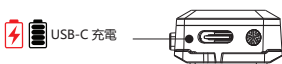
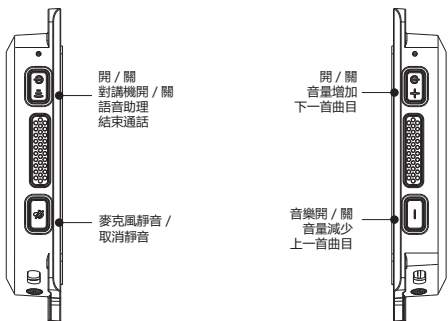
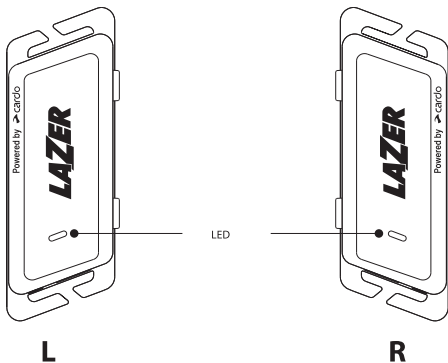

 開啟

首次使用：自動配對開啟

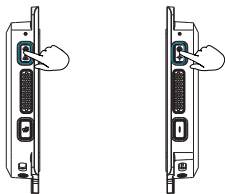

L

R

 關閉

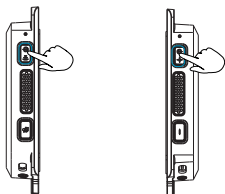

L

R



 如有需要：重新配對



R



LED 紅色&藍色指示燈 





下載



註冊

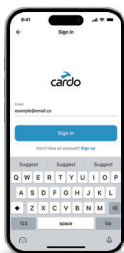

選擇語言

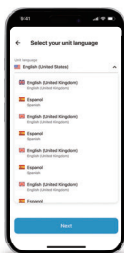

軟體更新



 音量增加



 音量減少



 語音助理



▶ 開啟



|| 關閉



▶ 下一首曲目



◀ 上一首曲目





接聽來電

按任意鍵接聽來電

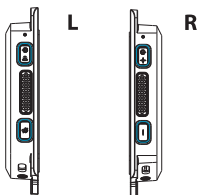

結束通話



L



對講機分組



對講機分組

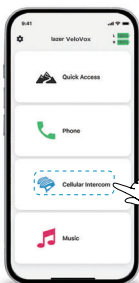

Cardo
連線應用程式
適用於 Lazer



對講機開 / 關



麥克風靜音



麥克風取消靜音



恢復原廠設定與重新啟動



恢復原廠設定

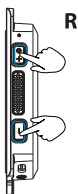

重新啟動

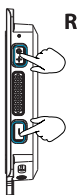

重設音訊模組

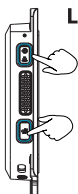

重設通訊模組

禧瑪諾互聯

禧瑪諾配對



- 1) 請更新您的 Di2 韌體。
- 2) 使用 Shimano E-Tube 應用程式，將 Shimano Di2 變速把上的按鈕設定為 D-Fly 頻道。
- 3) 按下變速把上的任一按鈕以進行配對。



- 1) 請更新您的韌體。
- 2) 使用 Shimano E-Tube 應用程式，將 Shimano EBIKE 系統上的按鈕設定為 D-Fly 頻道。
- 3) 開啟自行車電源以進行配對。

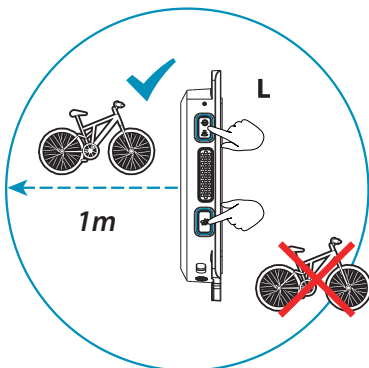

1. 請勿在周圍有其他自行車時進行配對
2. 請將您的自行車放置在 1 公尺以內的距離範圍內



LED 紅色&藍色指示燈





9:41



Shimano connectivity

D-FLY channel 1

Short press:

Mic mute / unmute

Double press:

Cycling information

Long press:

Voice assistance

D-FLY channel 2

Short press:

Unable/ disable group co...

Double press:

Music on / off

Long press:

Answer / end call

D-FLY channel 3

Short press:

Volume up

Double press:

Next track

Long press:

+ Add action

D-FLY channel 4

Short press:

Volume down

Double press:

Previous track

Long press:

+ Add action



開啟設定選單

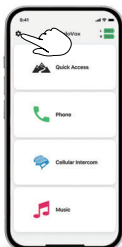

開啟禧瑪諾互聯

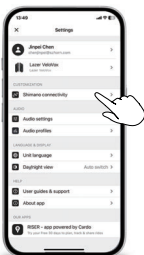

修改指令

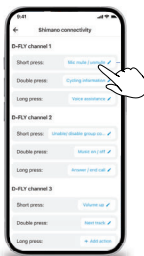

www.lazersport.com

LAZER

Reach out and follow us:

 @Lazersport

 LazerHelmets

 info@lazersport.com



Cardo
Connect App
for Lazer

Cardosystems.com/update

Cardosystems.com/support



LAZER

VeloVox

.....
KAPESNÍ PRŮVODCE

Polish

cardo

CONNECT

APP

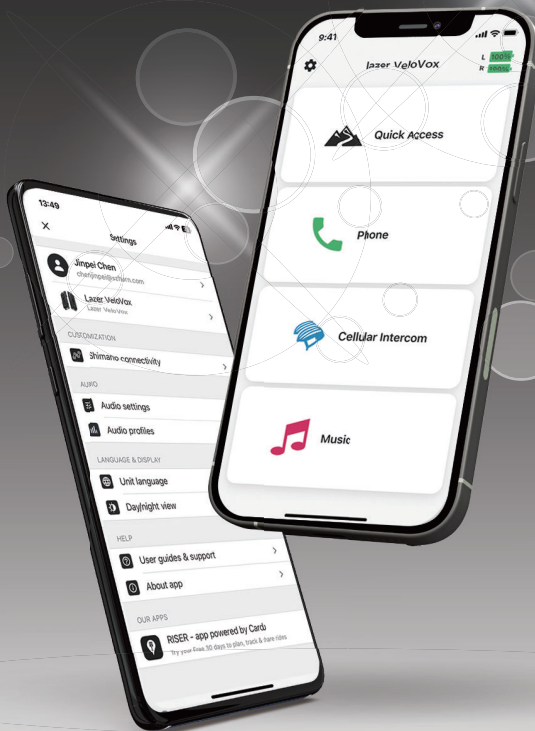

Cardo
Connect App
for Lazer



Obsah

4-5

Jak začít

6

Cardo Připojit App

7

Generální

8

Hudba

9

Telefonní hovor

10

Mobilní interkom

11

Przywracanie ustawień fabrycznych i restart

Pokročilé funkce

12

Připojení Shimano

13

Výchozí nastavení

14

Přizpůsobení připojení Shimano

Jak začít

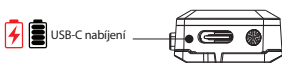
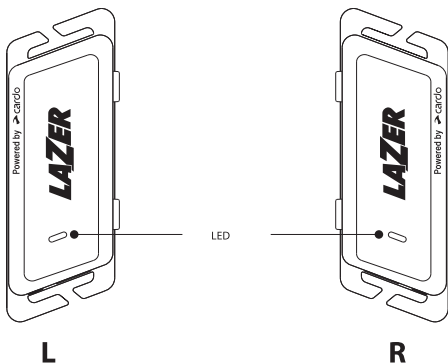

Stiskněte a přidržte



Počít klepnutí



ZAPNOUT

Poprvé: automatické párování
ZAPNUTO



L



R



VYPNOUT



L



R



V případě potřeby: spusťte nové párování

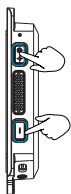

R



LED červená a modrá

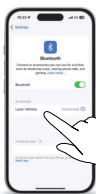



Stáhnout



Registrovat

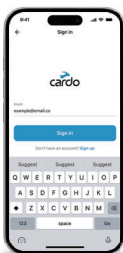

Vybrat Jazyk

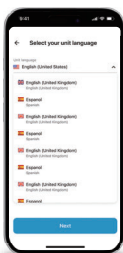

Aktualizovat Software



 Zvýšit hlasitost



 Snížit hlasitost



 Hlasový asistent



 ZAPNOUT



 VYPNOUT



 Další skladba



 Předchozí skladba



Telefonní hovor



Odpovědět

Stisknutím libovolného tlačítka odpovězte na telefonní hovor

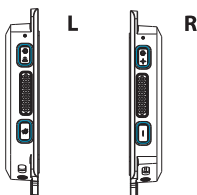

Ukončit hovor



Mobilní interkom



Seskupení interkomu

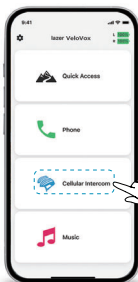

Cardo
Připojit App
pro Lazer



ZAP/VYP interkom



Ztlumit mikrofon



Zapnout mikrofon



Przywracanie ustawień fabrycznych i restart



Przywracanie ustawień fabrycznych



Restart



Resetowanie jednostki audio



Resetowanie jednostki komunikacyjnej

Pokročilé funkce

Připojení Shimano



Párování Shimano

Di2
DIGITAL INTEGRATED INTELLIGENCE

- 1) Aktualizujte firmware řadič páčky Di2.
- 2) Nastavte tlačítko (tlačítka) na řadič páče Shimano Di2 na kanál D-Fly pomocí aplikace Shimano E-Tube.
- 3) Stiskněte libovolné tlačítko na řadič páče pro párování.



SHIMANO
E-BIKE
SYSTEMS

- 1) Aktualizujte firmware.
- 2) Nastavte tlačítko(tlačítka) na systémech Shimano EBIKE na kanál D-Fly pomocí aplikace Shimano E-Tube.
- 3) Zapněte kolo pro párování.

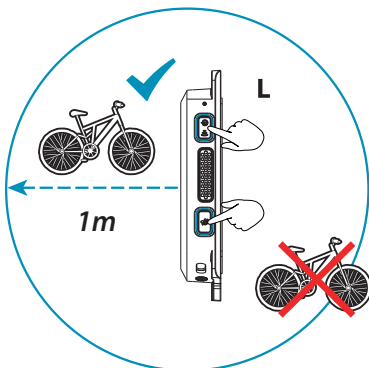

1. Nepárujte, když je v blízkosti jiné kolo
2. Neumísťujte kolo dále než 1 m



LED červená a modrá





9:41



Shimano connectivity

D-FLY channel 1

Short press:

Mic mute / unmute

Double press:

Cycling information

Long press:

Voice assistance

D-FLY channel 2

Short press:

Unable/ disable group co...

Double press:

Music on / off

Long press:

Answer / end call

D-FLY channel 3

Short press:

Volume up

Double press:

Next track

Long press:

+ Add action

D-FLY channel 4

Short press:

Volume down

Double press:

Previous track

Long press:

+ Add action

Přizpůsobení připojení Shimano



Otevřít menu Nastavení

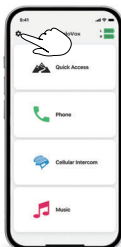

Otevřít připojení Shimano

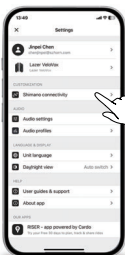

Změnit příkazy

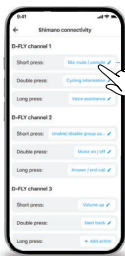

www.lazersport.com

LAZER

Reach out and follow us:

 @Lazersport

 LazerHelmets

 info@lazersport.com



Cardo
Connect App
for Lazer

Cardosystems.com/update

Cardosystems.com/support



LAZER

VeloVox

.....
KAPESNÍ PRŮVODCE

Czech

cardo CONNECT APP

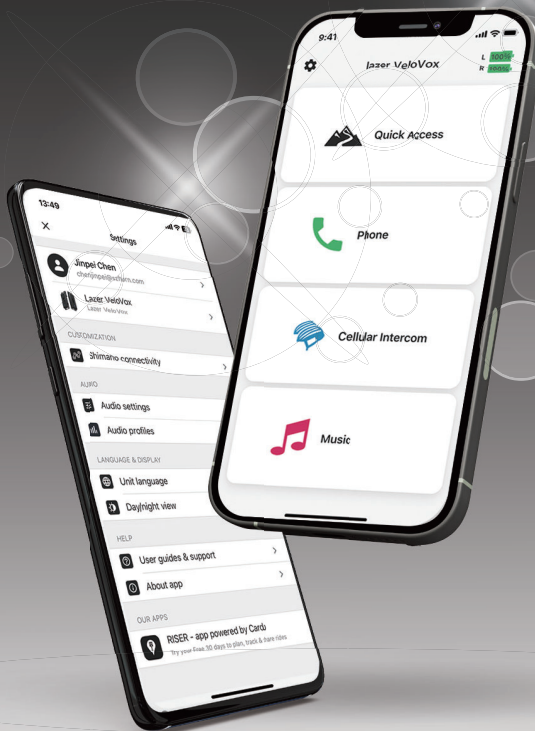

Cardo
Connect App
for Lazer



4-5

Jak začít

6

Cardo Připojit App

7

Generální

8

Hudba

9

Telefonní hovor

10

Mobilní interkom

11

Resetovat a restartovat tovární nastavení

Pokročilé funkce

12

Připojení Shimano

13

Výchozí nastavení

14

Přizpůsobení připojení Shimano

Jak začít

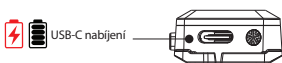
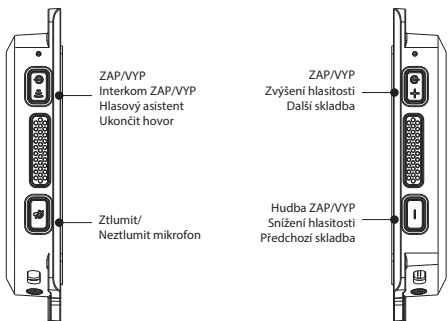
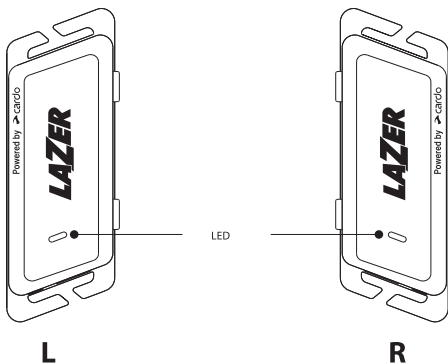

Stiskněte a přidržte



Počít klepnutí



ZAPNOUT

Poprvé: automatické párování
ZAPNUTO



L



R



VYPNOUT



L



R



V případě potřeby: spusťte nové párování

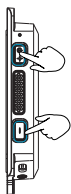

R

LED červená a modrá





Stáhnout



Herunterladen auf der App Store



START AUF Google Play



Registrovat

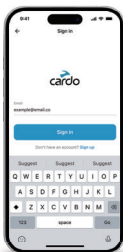

Vybrat Jazyk

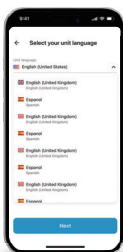

Aktualizovat Software



 Zvýšit hlasitost



 Snížit hlasitost



 Hlasový asistent



 ZAPNOUT



 VYPNOUT



 Další skladba



 Předchozí skladba



Telefonní hovor



Odpovědět

Stisknutím libovolného tlačítka odpovězte na telefonní hovor

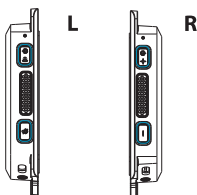

Ukončit hovor



Mobilní interkom



Seskupení interkomu

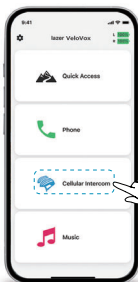

Cardo
Připojit App
pro Lazer



ZAP/VYP interkom



Ztlumit mikrofon



Zapnout mikrofon



Resetovat a restartovat tovární nastavení



Resetovat tovární nastavení

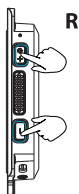

Restartovat

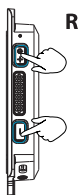

Resetovat zvukovou jednotku



Resetovat komunikační jednotku

Připojení Shimano



Párování Shimano



- 1) Aktualizujte firmwaré řadicí páčky Di2.
- 2) Nastavte tlačítko (tlačítka) na řadicí páčce Shimano Di2 na kanál D-Fly pomocí aplikace Shimano E-Tube.
- 3) Stiskněte libovolné tlačítko na řadicí páčce pro párování.



- 1) Aktualizujte firmwaré.
- 2) Nastavte tlačítko(tlačítka) na systémech Shimano EBIKE na kanál D-Fly pomocí aplikace Shimano E-Tube.
- 3) Zapněte kolo pro párování.

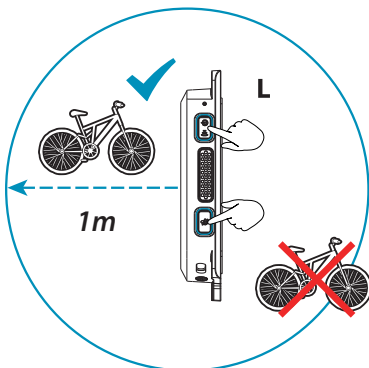

1. Nepárujte, když je v blízkosti jiné kolo
2. Neumístujte kolo dále než 1 m



LED červená a modrá





9:41



Shimano connectivity

D-FLY channel 1

Short press:

Mic mute / unmute

Double press:

Cycling information

Long press:

Voice assistance

D-FLY channel 2

Short press:

Unable/ disable group co...

Double press:

Music on / off

Long press:

Answer / end call

D-FLY channel 3

Short press:

Volume up

Double press:

Next track

Long press:

+ Add action

D-FLY channel 4

Short press:

Volume down

Double press:

Previous track

Long press:

+ Add action

Přizpůsobení připojení Shimano



Otevřít menu Nastavení

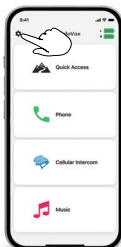

Otevřít připojení Shimano

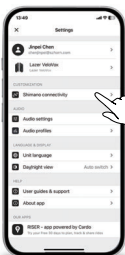

Změnit příkazy

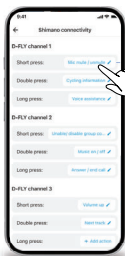

www.lazersport.com

LAZER

Reach out and follow us:

 @Lazersport

 LazerHelmets

 info@lazersport.com



Cardo
Connect App
for Lazer

Cardosystems.com/update

Cardosystems.com/support



LAZER

VeloVox

.....
FICKGUIDE

Swedish

cardo CONNECT APP

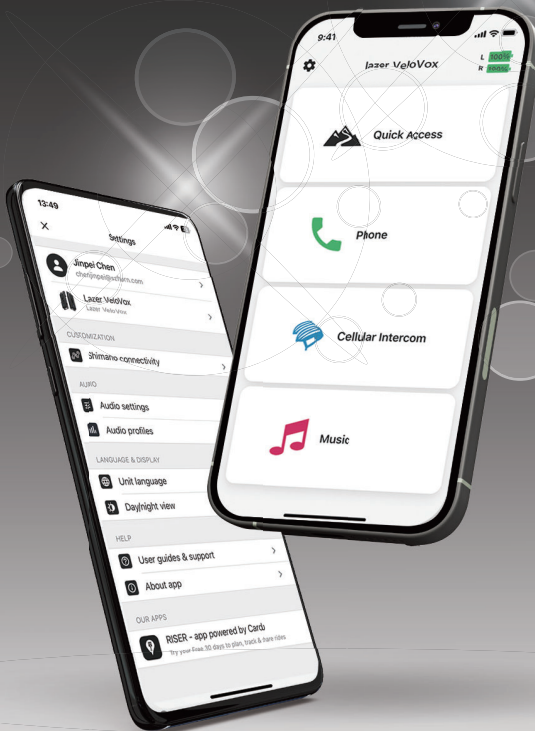

Cardo
Connect App
for Lazer



Innehållsförteckning

4-5

Komma igång

6

Cardo Connect APP

7

Allmänt

8

Musik

9

Telefonsamtal

10

Mobilintercom

11

Fabriksåterställning och omstart

Avancerade funktioner

12

Shimano-anlutning

13

Standardinställningar

14

Anpassa Shimano-anlutning

Komma igång

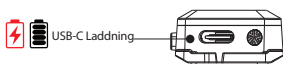
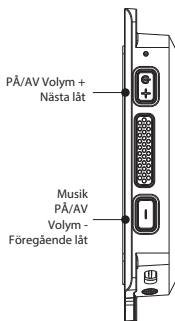
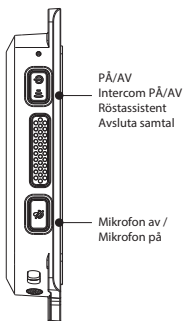
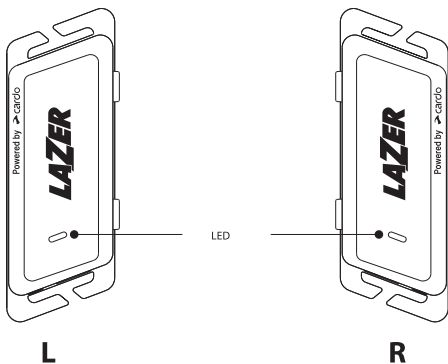

Tryck och Håll



Antal Tryckningar



PÅ

Första gången: automatisk parkoppling PÅ



L



R



AV



L



R



Om needed: starta ny parkoppling



R



LED Röd & Blå





Ladda ner



Registrera dig

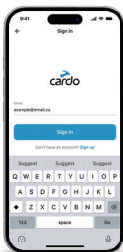

Välj språk

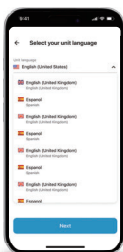

Uppdatera mjukvara



Allmänna inställningar

 Volym +



 Volym -



 Röstassistent



 PÅ



 X2
Tap

 AV



 X2
Tap

 Nästa spår



 X2
Tap

 Föregående spår



 X3
Tap

Telefon Samtal



Svara

Tryck på valfri knapp för att svara på samtalet

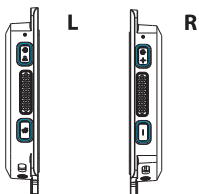

Avsluta samtal



L



Intercom-gruppering



Cardo
Connect-appen
för Lazer



Intercom PÅ/AV



Tysta mikrofonen



Sluta tysta mikrofonen



Fabriksåterställning och omstart



Fabriksåterställning

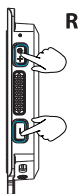

Omstart

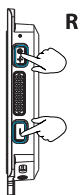

Återställ ljudenhet

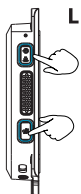

Återställ kommunikationsenhet

Avancerade funktioner

Shimano-koppling

Di2
DIGITAL INTEGRATED INTELLIGENCE

- 1) Uppdatera din Di2-mjukvara.
- 2) Tilldela knapp(ar) på Shimano Di2-växlarna till en D-Fly-kanal via Shimano E-Tube-appen.
- 3) Tryck på valfri knapp på växlaren för att parkoppla



SHIMANO
E-BIKE
SYSTEMS

- 1) Uppdatera din mjukvara.
- 2) Tilldela knapp(ar) på Shimano E-BIKE-systemet till en D-Fly-kanal via Shimano E-Tube-appen.
- 3) Slå på cykeln för att parkoppla.

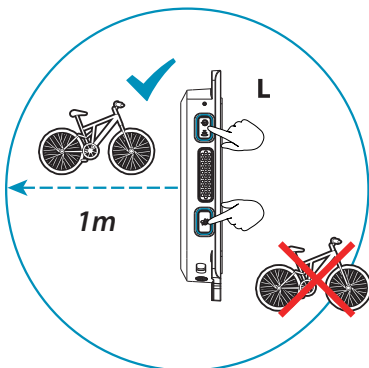

1. Para inte när andra cyklar finns i närheten
2. Placera din cykel inom 1 meters avstånd



Röd & blå LED





Översikt över standardinställningar

9:41



Shimano connectivity

D-FLY channel 1

Short press:

Mic mute / unmute

Double press:

Cycling information

Long press:

Voice assistance

D-FLY channel 2

Short press:

Unable/ disable group co...

Double press:

Music on / off

Long press:

Answer / end call

D-FLY channel 3

Short press:

Volume up

Double press:

Next track

Long press:

+ Add action

D-FLY channel 4

Short press:

Volume down

Double press:

Previous track

Long press:

+ Add action

Anpassa Shimano-anslutning

Öppna inställningsmenyn

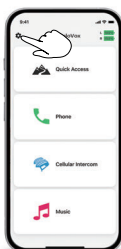

Öppna Shimano-anslutning

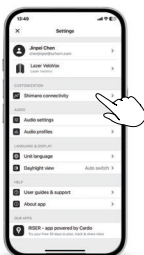

Ändra kommandon

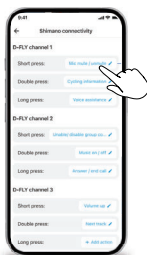

www.lazersport.com

LAZER

Reach out and follow us:

 @Lazersport

 LazerHelmets

 info@lazersport.com



Cardo
Connect App
for Lazer

Cardosystems.com/update

Cardosystems.com/support



LAZER

VeloVox

.....
LommeGuide
Norwegian

cardo CONNECT APP

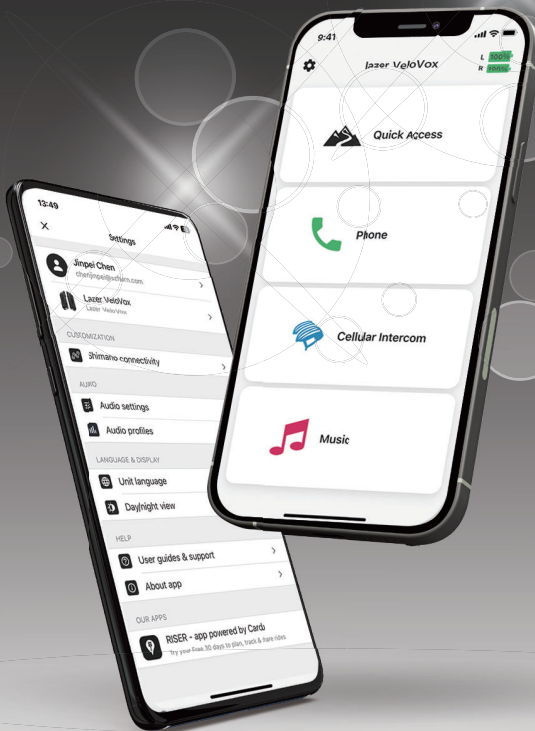

Cardo
Connect App
for Lazer



Innholdsfortegnelse

4-5

Komme i gang

6

Cardo Connect-appen

7

Generelt

8

Musikk

9

Telefonsamtaler

10

Trådløs intercom

11

Tilbakestilling til fabrikkinnstillinger og omstart

Advanced Features

12

Shimano-tilkobling

13

Standardinnstillinger

14

Tilpassing av Shimano-tilkobling

Komme i Gang

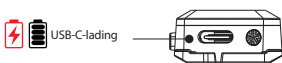
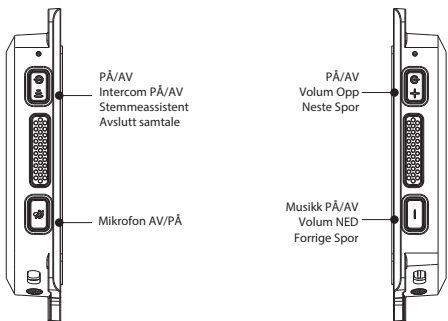
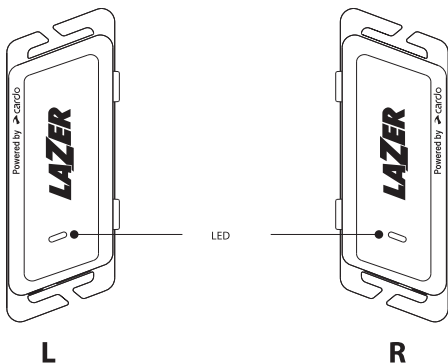

Trykk og hold



Antall trykk



PÅ

Første gang: automatisk paring PÅ



L



R



AV



L



R



Ved behov: start ny paring



R



LED Rød og Blå





Last ned

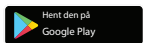
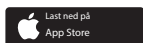

Registrere



Velg språk

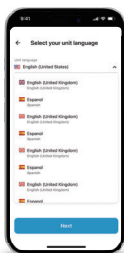

Oppdater programvare



Generelt

 Volum opp



 Volum ned



 Stemmeassistent



 PÅ





 AV





 Neste spor





 Forrige spor





Telefonsamtale



Trykk på en knapp for å svare på samtalen

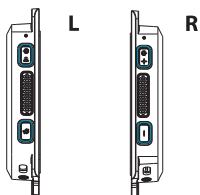

Trådløs Intercom



Intercom-gruppe

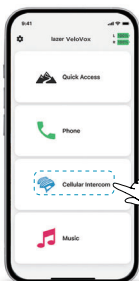

Cardo
Connect-appen
for Lazer



Intercom PÅ/AV



Mikrofon AV



Mikrofon PÅ



Tilbakestilling til fabrikkinnstillinger og omstart



Tilbakestilling til fabrikkinnstillinger



Omstart

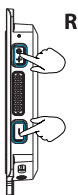

Tilbakestill lydenhet

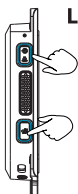

Tilbakestill kommunikasjonsenhet

Avanserte funksjoner

Shimano-tilkobling

Shimano-paring

Di2
DIGITAL INTEGRATED INTELLIGENCE

- 1) Oppdater Di2-fastvaren din.
- 2) Tilordne knapp(er) på Shimano Di2-girspakene til en D-Fly-kanal via Shimano E-Tube-appen.
- 3) Trykk på en knapp på girspaken for å starte paring.



SHIMANO
E-BIKE
SYSTEMS

- 1) Oppdater fastvaren din.
- 2) Tilordne knapp(er) på Shimano EBIKE-systemet til en D-Fly-kanal ved hjelp av Shimano E-Tube-appen.
- 3) Lülita jalgratas sisse sidumiseks. Slå på sykkelen for å starte paring.

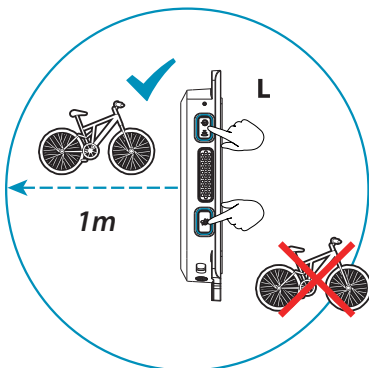

1. Ikke gjennomfør paring når andre sykler er i nærheten.
2. Hold sykkelen din innen 1 meters avstand.



LED Rød og Blå





9:41



Shimano connectivity

D-FLY channel 1

Short press:

Mic mute / unmute

Double press:

Cycling information

Long press:

Voice assistance

D-FLY channel 2

Short press:

Unable/ disable group co...

Double press:

Music on / off

Long press:

Answer / end call

D-FLY channel 3

Short press:

Volume up

Double press:

Next track

Long press:

+ Add action

D-FLY channel 4

Short press:

Volume down

Double press:

Previous track

Long press:

+ Add action

Åpne Innstillinger-menyen

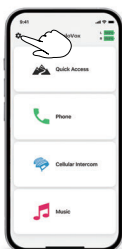

Åpne Shimano Connectivity

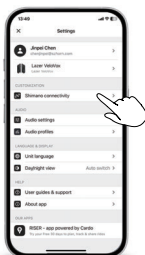

Endre kommandoer

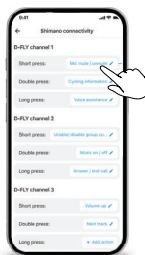

www.lazersport.com

LAZER

Reach out and follow us:

 @Lazersport

 LazerHelmets

 info@lazersport.com



Cardo
Connect App
for Lazer

Cardosystems.com/update

Cardosystems.com/support



LAZER

VeloVox

.....
LOMMEGUIDE

Danish

cardo CONNECT APP

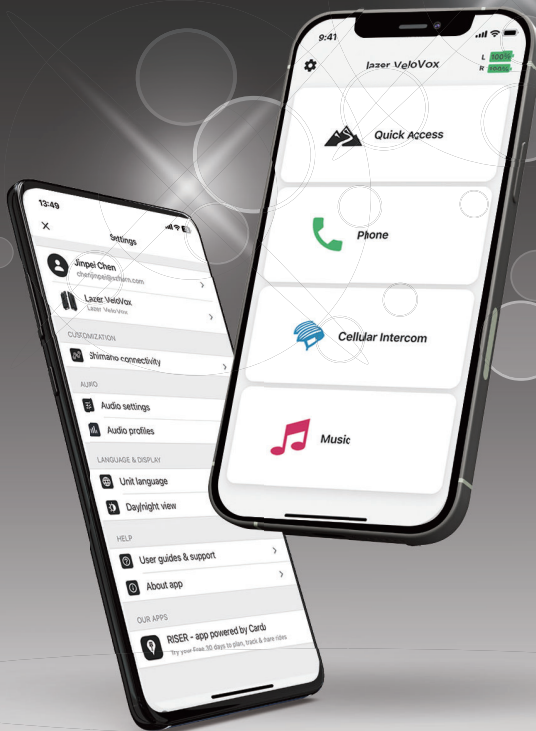

Cardo
Connect App
for Lazer



Indholdsfortegnelse

4-5

Kom Godt i Gang

6

Cardo Connect App

7

Generelt

8

Musik

9

Telefon

10

Mobil Intercom

11

Fabrikant nulstilling & Genstart

Avancerede Funktioner

12

Shimano Forbindelsesløsning

13

Standardindstillinger

14

Tilpasning af Shimano Forbindelsesløsning

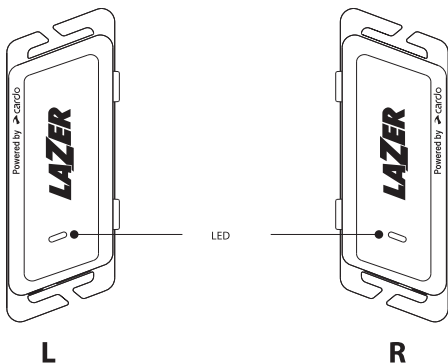

Tryk & Hold nede



Antal lette tryk

 Tænd

Første gang: automatisk parring TÆNDING



L



R

 Sluk



L



R



 Hvis nødvendigt: Start ny parring

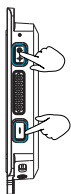

R



LED Rød & Blå 





Download



Download on the
App Store



GET IT ON
Google Play



Registrer

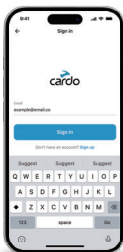

Vælg Sprog

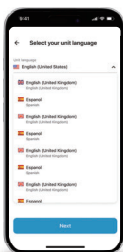

Opdater Software



Lydstyrke Op



Lydstyrke Ned



Stemmeassistent



 Afspil



 Hold Pause



 Næste Spor



 Forrige Spor





Svar

Tryk på en vilkårlig knap for at besvare opkaldet.

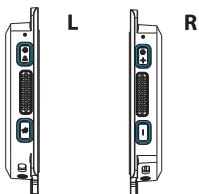

Afslut





Intercom Gruppering

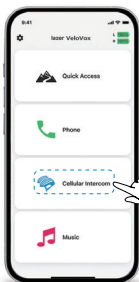

Cardo
Connect App
for Lazer



Intercom TÆND/SLUK



Slå Mikrofon Fra



Slå Mikrofon Til



Fabrikant nulstilling & Genstart



Fabrikant nulstilling

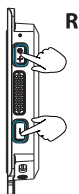

Genstart

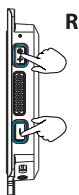

Nulstil audioenhet



Nulstil kommunikationsenhet

Avancerede Funktioner

Shimano Forbindelsesløsning

Shimano Parring

Di2
DIGITAL INTEGRATED INTELLIGENCE

- 1) Opdater din Di2 firmware.
- 2) Indstil knap (per) på Shimano Di2-gearstænger til en D-Fly-kanal med Shimano E-Tube-appen.
- 3) Tryk på en vilkårlig knap på gearstang for at parre.



SHIMANO
E-BIKE
SYSTEMS

- 1) Opdater din firmware.
- 2) Indstil knap (per) på Shimano E-CYKEL til en D-Fly-kanal med Shimano E-Tube-appen.
- 3) Tænd cyklen for at parre.

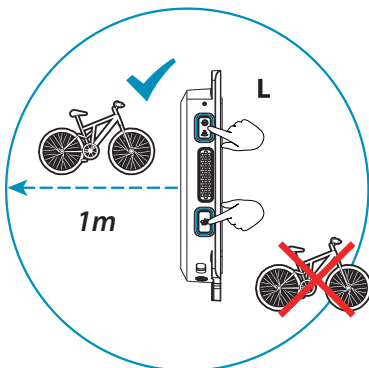

1. Par ikke, når der er andre cykler i nærheden
2. Hold din cykel inden for 1 m afstand



LED Rød & Blå





9:41



Shimano connectivity

D-FLY channel 1

Short press:

Mic mute / unmute

Double press:

Cycling information

Long press:

Voice assistance

D-FLY channel 2

Short press:

Unable/ disable group co...

Double press:

Music on / off

Long press:

Answer / end call

D-FLY channel 3

Short press:

Volume up

Double press:

Next track

Long press:

+ Add action

D-FLY channel 4

Short press:

Volume down

Double press:

Previous track

Long press:

+ Add action

Tilpasning af Shimano Forbindelsesløsning



Åbn Indstillingsmenu

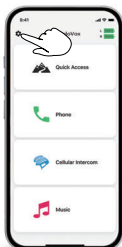

Åbn Shimano Forbindelsesløsning

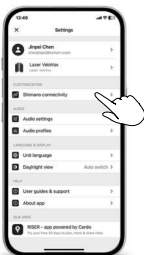

Ændr Kommandoer

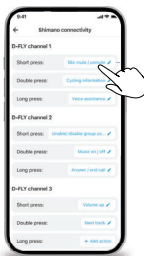

www.lazersport.com

LAZER

Reach out and follow us:

 @Lazersport

 LazerHelmets

 info@lazersport.com



Cardo
Connect App
for Lazer

Cardosystems.com/update

Cardosystems.com/support



LAZER

VeloVox

.....
TASKUOPAS

Finnish

cardo CONNECT APP

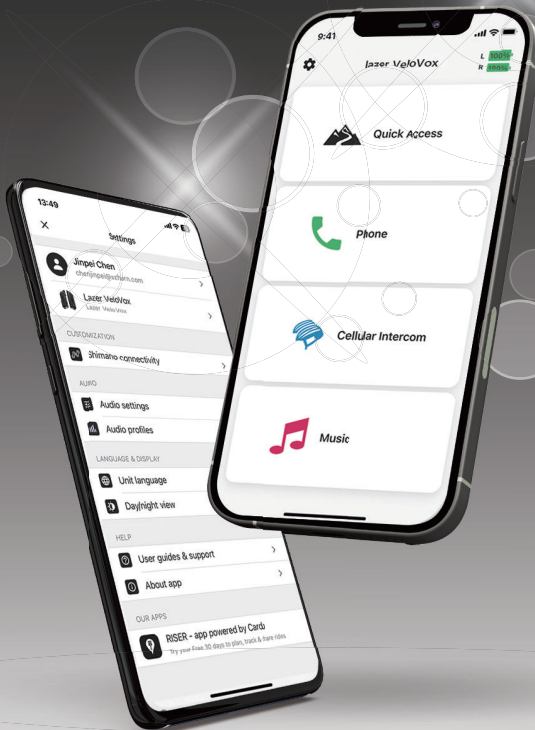

Cardo
Connect App
for Lazer



4-5

Aloituspöytä

6

Cardo Connect APP

7

Yleiset asetukset

8

Musiikki

9

Puhelut

10

Matkaviestin

11

Tehdasasetusten palautus ja uudelleenkäynnistys

Lisäominaisuudet

12

Shimano-yhteensopivuus

13

Oletusasetukset

14

Shimano-yhteyden mukauttaminen

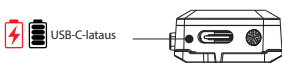
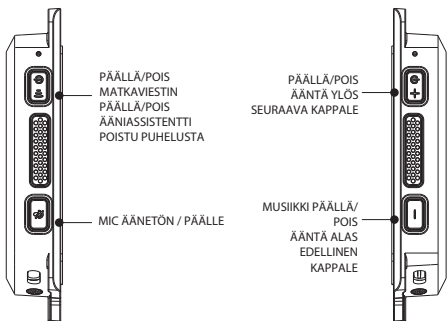
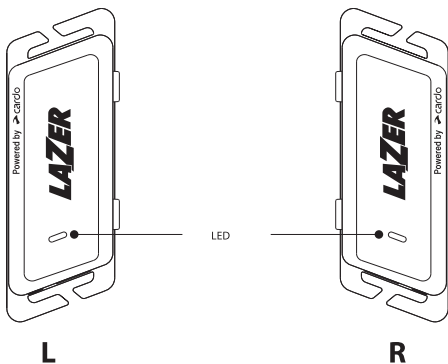

PAINA JA PIDÄ



NAPUTUSTEN MÄÄRÄ

 PÄÄLLÄ

Ensimmäisellä kerralla:
automaattinen paritus PÄÄLLÄ



L



R

 POIS



L

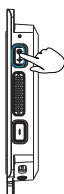

R



 Tarvittaessa: aloita uusi paritus



R



LED Punainen & Sininen 





Lataa

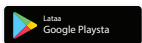
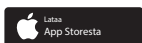

Rekisteröidy

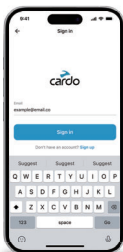

Valitse kieli

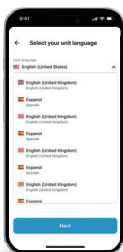

Päivitä ohjelmisto



 Ääntä ylös



 Ääntä alas



 Ääniohjain



▶ PÄÄLLÄ



X2
Tap

|| POIS



X2
Tap

▶▶ Seuraava kappale



X2
Tap

◀ Edellinen kappale



X3
Tap



Vastaa

Vastaa puheluun
painamalla mitä tahansa
näppäintä

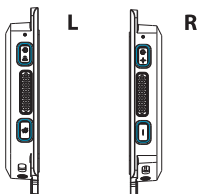

Lopeta puhelu



Matkaviestin



Ryhmäparitus

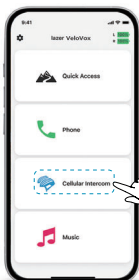

Cardo
Connect-sovellus
Lazerille



Matkaviestin PÄÄLLÄ/POIS



Mykistä mikrofoni



Poista mikrofoniin mykistys



Tehdasasetusten palautus ja uudelleenkäynnistys



Tehdasasetusten palautus



Uudelleenkäynnistys



Palauta äänilaite



Palauta viestintäyksikkö

Shimano-yhteensopivuus

Shimano-paritus

Di2
DIGITAL INTEGRATED INTELLIGENCE

- 1) Päivitä Di2-laitteistosi ohjelmisto.
- 2) Määritä Shimano Di2-vaihteenappula(t) D-Fly-kanavalle Shimano E-Tube -sovelluksella.
- 3) Aloita paritus painamalla mitä tahansa vaihteenappulaa.



SHIMANO
E-BIKE
SYSTEMS

- 1) Päivitä laitteistosi ohjelmisto.
- 2) Määritä Shimano EBIKE-järjestelmän näppäin(t) D-Fly-kanavalle Shimano E-Tube-sovelluksella.
- 3) Käynnistä pyörä parituksen aloittamiseksi.

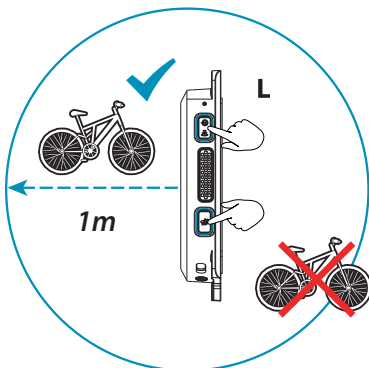

1. Älä parita, jos lähistöllä on toinen pyörä
2. Sijoita pyöräsi enintään 1 metrin päähän



LED Punainen & Sininen" 



9:41



Shimano connectivity

D-FLY channel 1

Short press:

Mic mute / unmute

Double press:

Cycling information

Long press:

Voice assistance

D-FLY channel 2

Short press:

Unable/ disable group co...

Double press:

Music on / off

Long press:

Answer / end call

D-FLY channel 3

Short press:

Volume up

Double press:

Next track

Long press:

+ Add action

D-FLY channel 4

Short press:

Volume down

Double press:

Previous track

Long press:

+ Add action

Mukauta Shimano-yhteyksiä



Avaa asetusvalikko

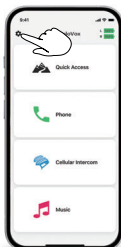

Avaa Shimano-yhteensopivuus

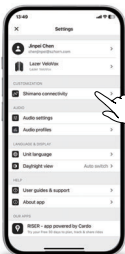

Muokkaa komentoja

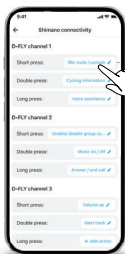

www.lazersport.com

LAZER

Reach out and follow us:

 @Lazersport

 LazerHelmets

 info@lazersport.com



Cardo
Connect App
for Lazer

Cardosystems.com/update

Cardosystems.com/support



LAZER

VeloVox

.....
ΤΣ'ΕΠΙΟΣ ΟΔΗΓΟΣ

Greek

cardo CONNECT APP

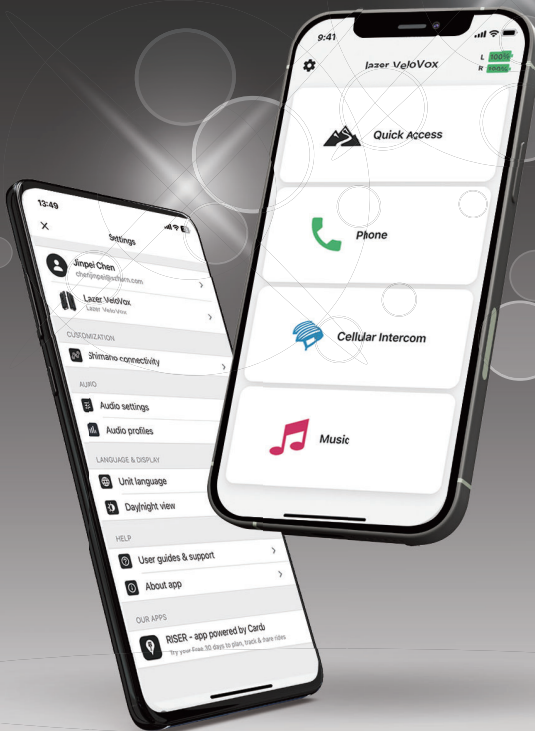

Cardo
Connect App
for Lazer



Πίνακας Περιεχομένων

4-5

Εκκίνηση

6

Εφαρμογή Cardo Connect

7

Γενικά

8

Μουσική

9

Τηλεφωνική κλήση

10

Διασυνδεδεμένο

11

Επαναφορά εργοστασιακών ρυθμίσεων και επανεκκίνηση

Σύνθετες λειτουργίες

12

Σύνδεση Shimano

13

Προεπιλεγμένες Ρυθμίσεις

14

Προσαρμογή Σύνδεσης Shimano

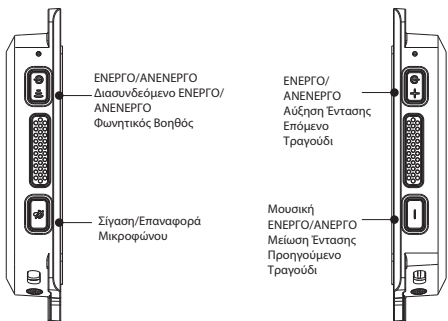
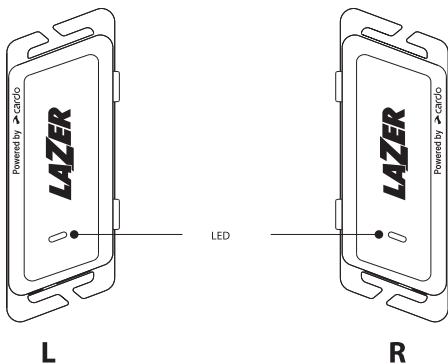

Πάτημα και Κράτημα



Αριθμός Πατημάτων

 ΕΝΕΡΓΟ

Πρώτη χρήση: αυτόματη σύζευξη ΕΝΕΡΓΟ



L



R

 ΑΝΕΝΕΡΓΟ



L



R



 Εάν χρειαστεί: Ξεκινήστε νέα σύζευξη

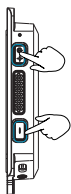

R



LED Κόκκινο & Μπλε

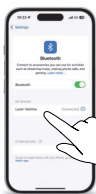



Λήψη



Εγγραφή

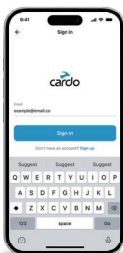

Επιλογή Γλώσσας

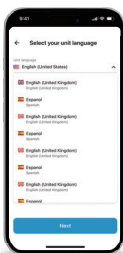

Ενημέρωση Λογισμικού



 Αύξηση Έντασης



 Μείωση Έντασης



 Φωνητικός Βοηθός



Επόμενο Κομμάτι

▶ ΕΝΕΡΓΟ



X2
Tap

|| ΑΝΕΝΕΡΓΟ



X2
Tap

▶▶ Επόμενο Κομμάτι



X2
Tap

◀ Προηγούμενο Κομμάτι



X3
Tap



Απάντηση

Πατήστε οποιοδήποτε
κουμπί για απάντηση

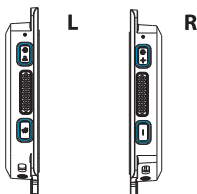

Τερματισμός Κλήσης



L



Διασυνδεδεμένο



Ομαδοποίηση Διασυνδεδεμένων

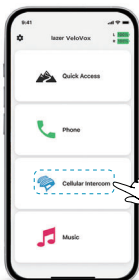

Εφαρμογή Cardo
Connect για Lazer



Διασυνδεδεμένο ΕΝΕΡΓΟ/ΑΝΕΝΕΡΓΟ



Σίγαση Μικροφώνου



Επαναφορά Μικροφώνου



Επαναφορά εργοστασιακών ρυθμίσεων και επανεκκίνηση



Επαναφορά εργοστασιακών ρυθμίσεων

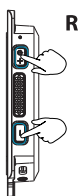

Επανεκκίνηση

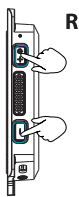

Επαναφορά μονάδας ήχου



Επαναφορά μονάδας επικοινωνίας

Προχωρημένες Λειτουργίες

Σύνδεση Shimano

Σύζευξη Shimano

Di2
DIGITAL INTEGRATED INTELLIGENCE

- 1) Ενημερώστε το υλικολογισμικό Di2
- 2) Ρυθμίστε τα κουμπιά στα Shimano Di2 shifters σε κανάλι D-Fly μέσω της εφαρμογής E-Tube
- 3) Πατήστε οποιοδήποτε κουμπι shifter για σύζευξη



SHIMANO
E-BIKE
SYSTEMS

- 1) Ενημερώστε το υλικολογισμικό σας
- 2) Ρυθμίστε τα κουμπιά στα συστήματα Shimano EBIKE σε κανάλι D-Fly μέσω της εφαρμογής Shimano E-Tube.
- 3) Ενεργοποιήστε το ποδήλατο για σύζευξη

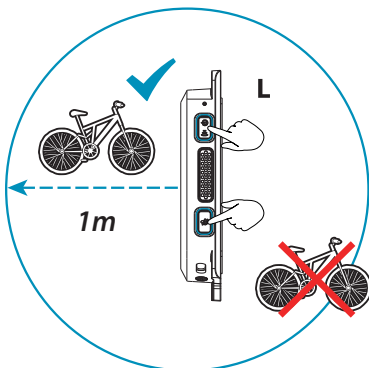

1. Να μην γίνεται σύζευξη παρουσία άλλων ποδηλάτων
2. Το ποδήλατο να απέχει το πολύ 1 μέτρο



LED Κόκκινο και Μπλε





9:41



Shimano connectivity

D-FLY channel 1

Short press:

Mic mute / unmute

Double press:

Cycling information

Long press:

Voice assistance

D-FLY channel 2

Short press:

Unable/ disable group co...

Double press:

Music on / off

Long press:

Answer / end call

D-FLY channel 3

Short press:

Volume up

Double press:

Next track

Long press:

+ Add action

D-FLY channel 4

Short press:

Volume down

Double press:

Previous track

Long press:

+ Add action

Προσαρμογή σύνδεσης Shimano



Άνοιγμα μενού ρυθμίσεων

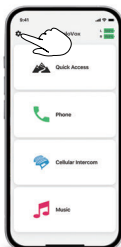

Άνοιγμα σύνδεσης Shimano

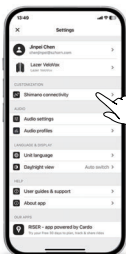

Αλλαγή εντολών

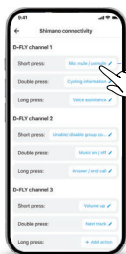

www.lazersport.com

LAZER

Reach out and follow us:

 @Lazersport

 LazerHelmets

 info@lazersport.com



Cardo
Connect App
for Lazer

Cardosystems.com/update

Cardosystems.com/support



LAZER

VeloVox

.....
GHID DE BUZUNAR

Romanian

cardo CONNECT APP

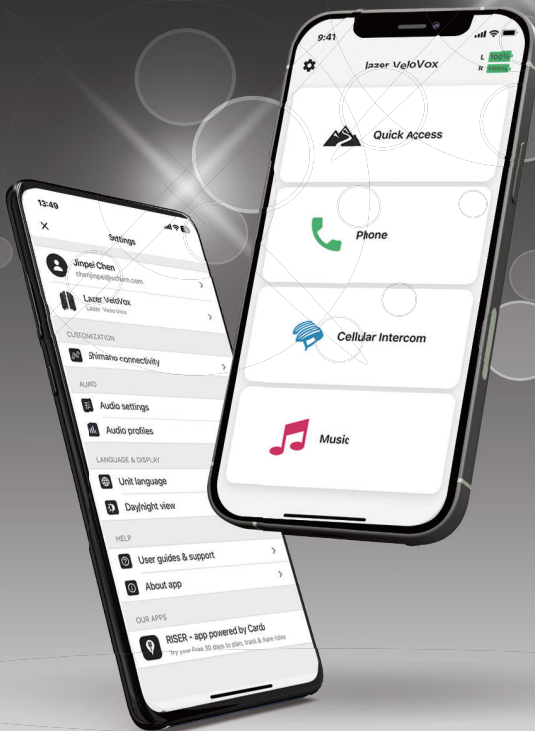

Cardo
Connect App
for Lazer



Cuprins

4-5

Ghid de început

6

App de conectare Cardo

7

General

8

Muzică

9

Apel telefonic

10

Interfon celular

11

Resetare din fabrică și repornire

Funcții avansate

12

Conectivitate Shimano

13

Setări implicite

14

Personalizarea conectivității Shimano

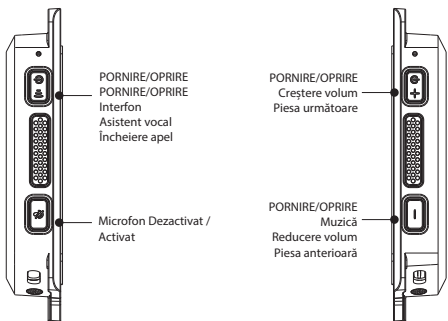
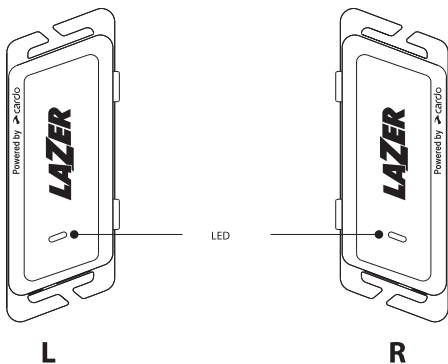

Apăsați și mențineți apăsat



Număr de apăsări



Pornire

Prima dată: împerechere automată ACTIVATĂ



L



R



Opreire



L



R



Dacă este necesar: începeți o împerechere nouă



R



LED Roșu & Albastru





Descărcare

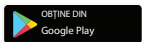
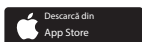

Înregistrare

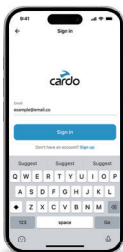

Alegere limbă

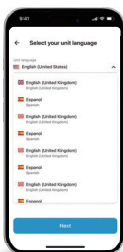

Actualizare software



General

 Creștere volum



 Reducere volum



 Asistent vocal



▶ Pornire



⏸ Oprește



▶▶ Piesa următoare



◀◀ Piesa anterioară



Apel telefonic



Preluare apel

Apăsați orice buton
pentru prelua apelul

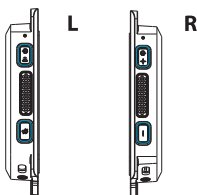

Încheiere apel



L

Interfon celular



Grupare interfon



App de conectare
Cardo
pentru Lazer



Pornire/ Oprire interfon



Dezactivare microfon



Activare microfon



Resetare din fabrică și repornire



Resetare din fabrică

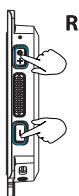

Repornire

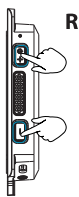

Resetare unitate audio



Resetare unitate de comunicație

Funcții avansate

Conectivitate Shimano



Împerechere Shimano

Di2
DIGITAL INTEGRATED INTELLIGENCE

- 1) Actualizați firmware-ul Di2.
- 2) Configurați butonul/butoanele de pe schimbătoare Shimano Di2 pe un canal D-Fly folosind app Shimano E-Tube.
- 3) Apăsați orice buton de pe schimbător pentru împerechere.



SHIMANO
E-BIKE
SYSTEMS

- 1) Actualizați firmware.
- 2) Configurați butonul/butoanele de pe sistemele Shimano EBIKE pe un canal D-Fly folosind app Shimano E-Tube.
- 3) Porniți bicicleta pentru împerechere.

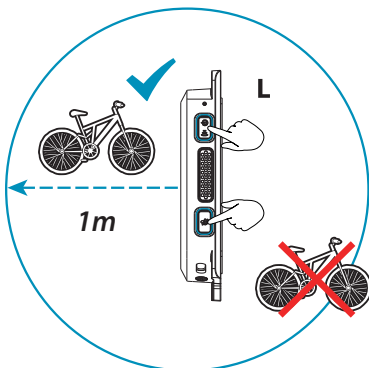

1. Nu faceți împerecherea dacă în apropiere se află o altă bicicletă
2. Puneți bicicleta la o distanță de maximum 1 m



LED Roșu & Albastru





Prezentare generală a setărilor implicite

9:41



Shimano connectivity

D-FLY channel 1

Short press:

Mic mute / unmute

Double press:

Cycling information

Long press:

Voice assistance

D-FLY channel 2

Short press:

Unable/ disable group co...

Double press:

Music on / off

Long press:

Answer / end call

D-FLY channel 3

Short press:

Volume up

Double press:

Next track

Long press:

+ Add action

D-FLY channel 4

Short press:

Volume down

Double press:

Previous track

Long press:

+ Add action



Deschideți meniul Setări

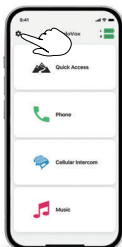

Deschideți Conectivitatea Shimano

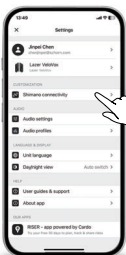

Schimbați comenzile



www.lazersport.com

LAZER

Reach out and follow us:

 @Lazersport

 LazerHelmets

 info@lazersport.com



Cardo
Connect App
for Lazer

Cardosystems.com/update

Cardosystems.com/support



LAZER

VeloVox

.....
РОКЪТ ГАЙД

Bulgarian

 **cardo**
CONNECT
APP

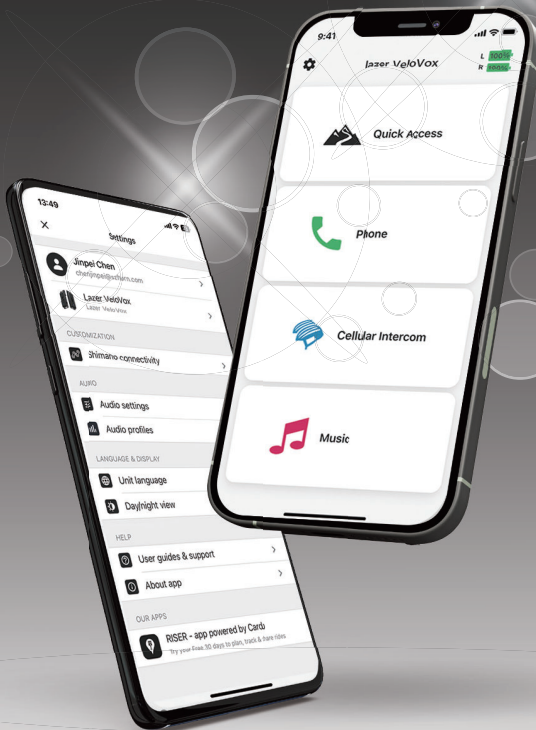

Cardo
Connect App
for Lazer



Съдържание

4-5

Начало

6

Cardo Connect App

7

Общи настройки

8

Музика

9

Телефонно обаждане

10

Групова интерком система

11

Фабрично нулиране и рестартиране

Разширени функции

12

Връзка с Shimano

13

Стандартни настройки

14

Персонализиране на Shimano връзката

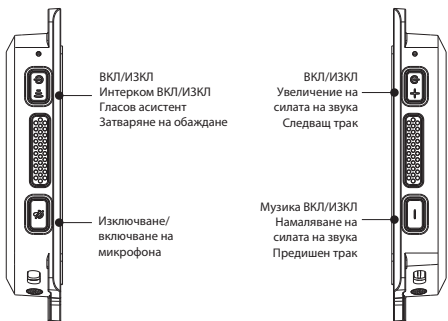
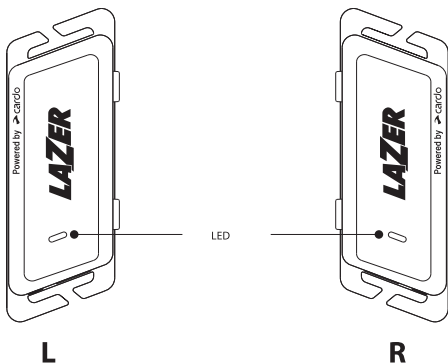

Натиснете и задръжте



Брой натискания



Първи път: автоматично свързване ВКЛ



L



R



L



R

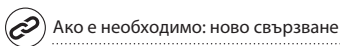

R



LED червено и синьо 





Изтегляне

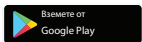
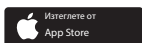

Регистрация

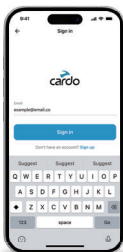

Избор на език

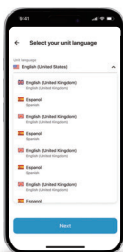

Актуализиране на софтуер



Общи настройки

 Увеличение на силата на звука



 Намаляване на силата на звука



 Гласов асистент



▶ ВКЛ



X2
Tap

⏸ ИЗКЛ



X2
Tap

▶▶ Следваща песен



X2
Tap

◀◀ Предишна песен



X3
Tap



Приемане

Натиснете бутон, за да отговорите на обаждането

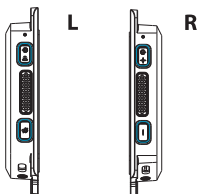

Затваряне на обаждане



Групова интерком система



Групиране на интерком

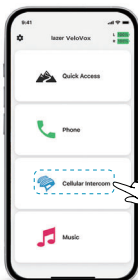

Cardo
Connect App
за Lazer



Интерком ВКЛ/ИЗКЛ



Заглушаване на микрофона



Включване на микрофона



Фабрично нулиране и рестартиране



Фабрично нулиране



Рестартиране

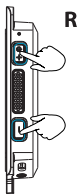

Нулиране на аудио модула



Нулиране на комуникационния модул

Разширени функции

Връзка с Shimano

Shimano Pairing

Di2
DIGITAL INTEGRATED INTELLIGENCE

- 1) Актуализирайте *firmware* на вашия Di2.
- 2) Настройте бутон(и) на Shimano Di2 превключвателите към D-Fly канал чрез приложението Shimano E-Tube.
- 3) Натиснете произволен бутон на превключвателя за свързване.



SHIMANO
E-BIKE
SYSTEMS

- 1) Актуализирайте вашия *firmware*.
- 2) Настройте бутон(и) на системите Shimano EBIKE към D-Fly канал чрез приложението Shimano E-Tube.
- 3) Включете велосипеда за свързване.

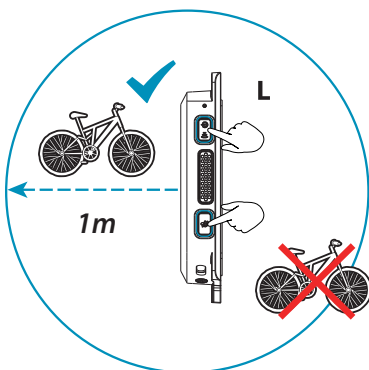

1. Не свързвайте, когато има други велосипеди наблизо
2. Поставете велосипеда си на не повече от 1 метър разстояние



LED червено и синьо





9:41



Shimano connectivity

D-FLY channel 1

Short press:

Mic mute / unmute

Double press:

Cycling information

Long press:

Voice assistance

D-FLY channel 2

Short press:

Unable/ disable group co...

Double press:

Music on / off

Long press:

Answer / end call

D-FLY channel 3

Short press:

Volume up

Double press:

Next track

Long press:

+ Add action

D-FLY channel 4

Short press:

Volume down

Double press:

Previous track

Long press:

+ Add action

Персонализиране на Shimano свързаността



Отваряне на меню Настройки

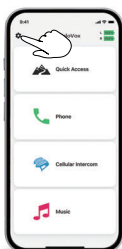

Отваряне на Shimano свързаност

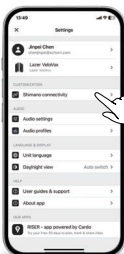

Промяна на команди



www.lazersport.com

LAZER

Reach out and follow us:

 @Lazersport

 LazerHelmets

 info@lazersport.com



Cardo
Connect App
for Lazer

Cardosystems.com/update

Cardosystems.com/support



LAZER

VeloVox

.....
ZSEBKALAUZ

Hungarian

cardo CONNECT APP

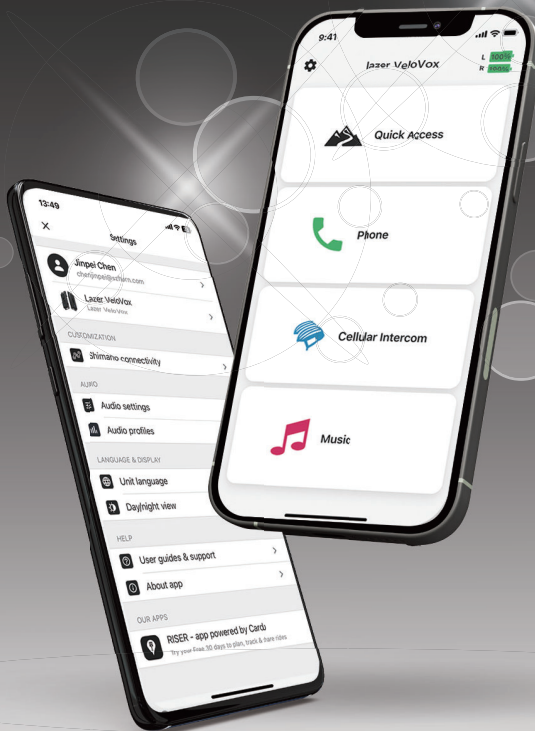

Cardo
Connect App
for Lazer



Tartalomjegyzék

4-5

Első lépések

6

Cardo Csatlakozó alkalmazás

7

Általános

8

Zene

9

Telefonhívás

10

Mobil intercom

11

Gyári beállítások visszaállítása és újraindítás

Haladó funkciók

12

Shimano kapcsolódás

13

Alapbeállítások

14

Shimano kapcsolódás testreszabása

Első lépések

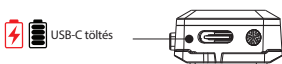
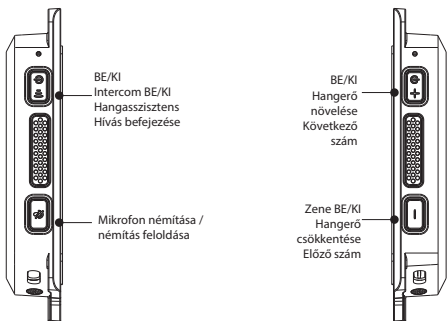
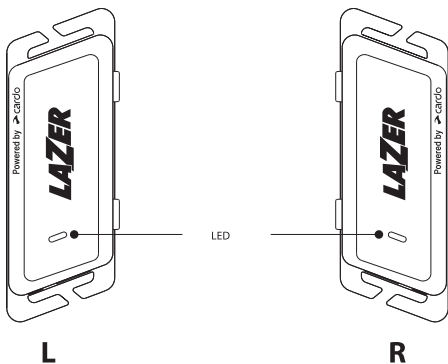

Tartsa & nyomva



Érintések száma



BE

Először: automatikus párosítás
BE



L



R



KI



L



R



Szükség esetén: indítsa el az új párosítást



R



LED Piros & Kék

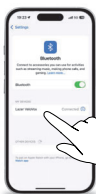



Letöltés



Regisztráció



Nyelv választása

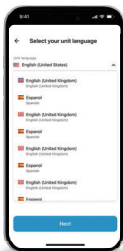

Szoftver frissítése



Hangerő növelése



Hangerő csökkentése



Hangasszisztens





BE



KI



Következő szám



Előző szám



Telefonhívás



Hívás fogadása

Nyomjon meg
bármelyik gombot a
hívás fogadásához

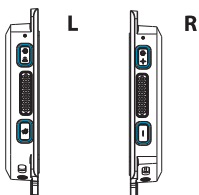

Hívás befejezése



L



Intercom csoportosítás

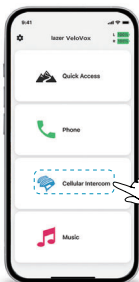

Cardo Connect
alkalmazás a Lazer
számára



Intercom BE/KI



Mikrofon némítása



Mikrofon némítás feloldása



Gyári beállítások visszaállítása és újraindítás



Gyári beállítások visszaállítása

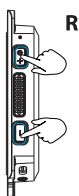

Újraindítás

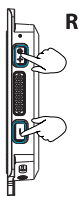

Hangmodul visszaállítása



Kommunikációs egység visszaállítása

Shimano kapcsolódás

Shimano párosítás

Di2
DIGITAL INTEGRATED INTELLIGENCE

- 1) Frissítse a Di2 firmware-t.
- 2) Állítsa be a Shimano Di2 váltókarokon lévő gombokat D-Fly csatornára a Shimano E-Tube alkalmazással.
- 3) Nyomjon meg bármelyik gombot a váltókaron a párosításhoz.



SHIMANO
E-BIKE
SYSTEMS

- 1) Frissítse a firmware-t.
- 2) Állítsa be a Shimano EBIKE rendszerek gombjait D-Fly csatornára a Shimano E-Tube alkalmazással.
- 3) Kapcsolja be a kerékpárt a párosításhoz.

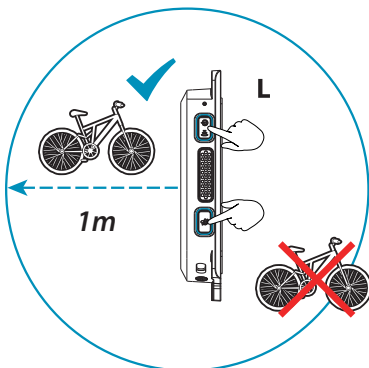

1. Ne párosítson, ha más kerékpár van a közelben
2. Helyezze a kerékpárt maximum 1 méterre



LED Piros & Kék





9:41



Shimano connectivity

D-FLY channel 1

Short press:

Mic mute / unmute

Double press:

Cycling information

Long press:

Voice assistance

D-FLY channel 2

Short press:

Unable/ disable group co...

Double press:

Music on / off

Long press:

Answer / end call

D-FLY channel 3

Short press:

Volume up

Double press:

Next track

Long press:

+ Add action

D-FLY channel 4

Short press:

Volume down

Double press:

Previous track

Long press:

+ Add action



Beállítások menü megnyitása

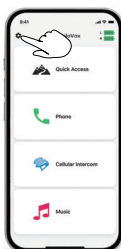

Shimano kapcsolódás megnyitása

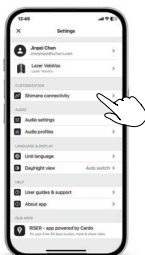

Parancsok módosítása

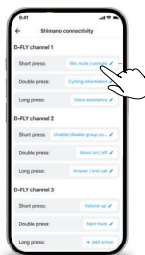

www.lazersport.com

LAZER

Reach out and follow us:

 @Lazersport

 LazerHelmets

 info@lazersport.com



Cardo
Connect App
for Lazer

Cardosystems.com/update

Cardosystems.com/support



LAZER

VeloVox

.....
ŽEPNI VODIČ
Slovenian

cardo CONNECT APP

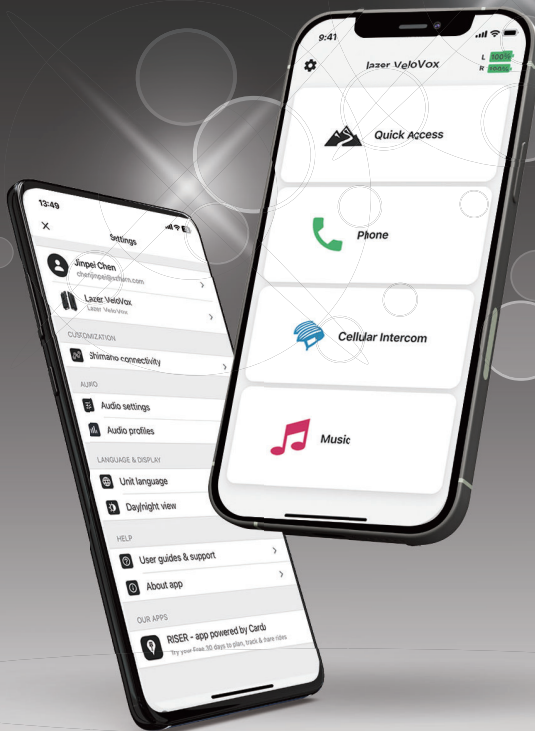

Cardo
Connect App
for Lazer



Kazalo vsebine

4-5

Začetek uporabe

6

Cardo Connect APP

7

Splošno

8

Glasba

9

Telefonski klic

10

Mobilni interkom

11

Tovarni ponastavitev in ponovni zagon

Napredne funkcije

12

Povezljivost s Shimano

13

Privzete nastavitve

14

Prilagajanje povezljivosti s Shimano

Začetek uporabe

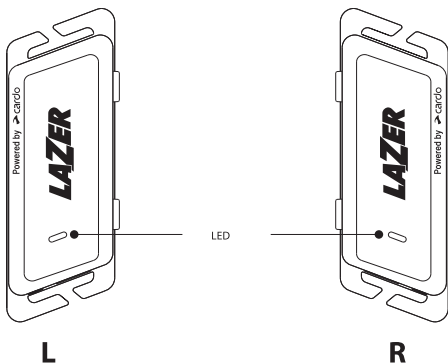

Pritisnite in Držite



Število Pritiskov



VKLOP

Prvič: samodejno seznanjanje VKLOP



L



R



IZKLOP



L



R



Po potrebi: začni novo seznanjanje



R



LED rdeča in modra





Prenesi



Registriraj se



Izberi jezik

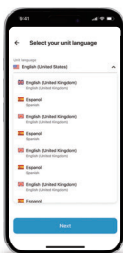

Posodobi programsko opremo





Povečaj glasnost



Zmanjšaj glasnost



Glasovni asistent



▶ Vklopi



|| Izklopi



▶▶ Naslednja skladba



◀◀ Prejšnja skladba



Telefonski klic



Sprejmi

Pritisnite katerikoli gumb
za odgovor na klice

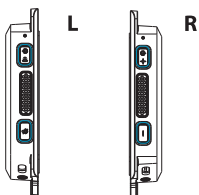

Končaj klic



Mobilni interkom



Interkom skupina

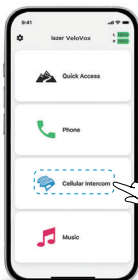

Cardo
Connect App
za Lazer



Interkom VKLOP/IZKLOP



Utisni mikrofون



Odtisni mikrofون



Tovarni ponastavitev in ponovni zagon



Tovarni ponastavitev



Ponovni zagon



Ponastavi zvočno enoto



Ponastavi komunikacijsko enoto

Napredne funkcije

Povezljivost s Shimano

Shimano Pairing

Di2
DIGITAL INTEGRATED INTELLIGENCE

- 1) Posodobite Di2 strojno opremo.
- 2) Nastavite gube na Shimano Di2 menjalnikih na D-Fly kanal s Shimano E-Tube aplikacijo.
- 3) Pritisnite katerikoli gumb na menjalniku za seznanjanje.



SHIMANO
E-BIKE
SYSTEMS

- 1) Posodobite svojo strojno opremo.
- 2) Nastavite gube na Shimano EBIKE sistemih na D-Fly kanal s Shimano E-Tube aplikacijo.
- 3) Vključite kolo za seznanjanje.

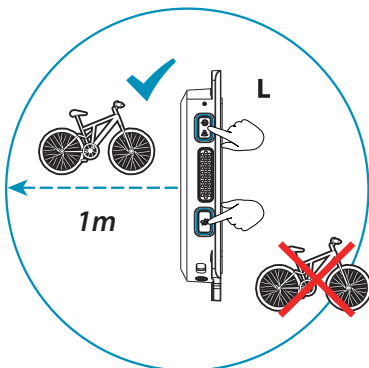

1. Ne seznanjajte, ko je v bližini drugo kolo
2. Postavite kolo ne dlje kot 1 meter



LED Rdeča in Modra





Pregled privzetih nastavitvev

9:41



Shimano connectivity

D-FLY channel 1

Short press:

Mic mute / unmute

Double press:

Cycling information

Long press:

Voice assistance

D-FLY channel 2

Short press:

Unable/ disable group co...

Double press:

Music on / off

Long press:

Answer / end call

D-FLY channel 3

Short press:

Volume up

Double press:

Next track

Long press:

+ Add action

D-FLY channel 4

Short press:

Volume down

Double press:

Previous track

Long press:

+ Add action

Prilagajanje povezljivosti s Shimano



Odpri meni nastavitvev

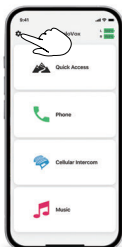

Odpri povezljivost s Shimano

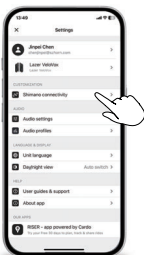

Spremeni ukaze

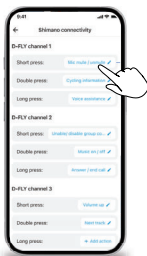

www.lazersport.com

LAZER

Reach out and follow us:

 @Lazersport

 LazerHelmets

 info@lazersport.com



Cardo
Connect App
for Lazer

Cardosystems.com/update

Cardosystems.com/support



LAZER

VeloVox

.....
PRUČNÝ SPRIEVODCA
Slovakian

cardo CONNECT APP

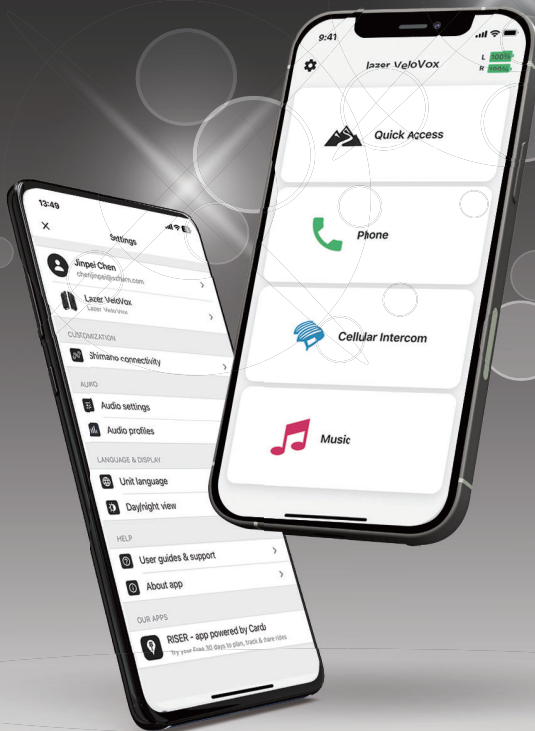

Cardo
Connect App
for Lazer



Obsah

4-5

Začíname

6

Cardo Connect App

7

Všeobecné

8

Hudba

9

Telefónny hovor

10

Mobilný interkom

11

Obnovenie výrobných nastavení a reštart

Pokročilé funkcie

12

Shimano pripojenie

13

Predvolené nastavenia

14

Prispôsobenie Shimano pripojenia

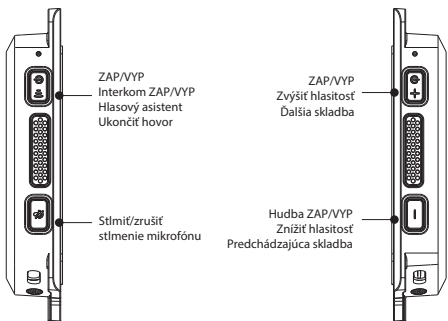
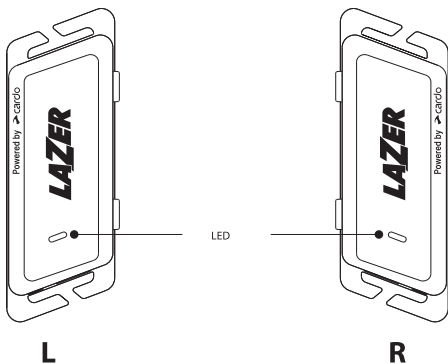

Stlačiť a podržať



Počet klepnutí

 ZAP

Prvýkrát: automatické párovanie ZAP

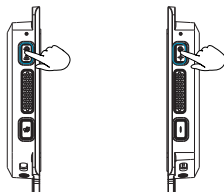

L

R

 VYP

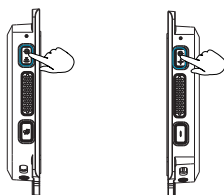

L

R



 V prípade potreby: začať nové párovanie



R



LED červená a modrá 

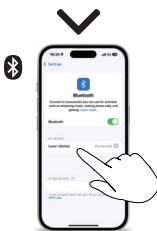



Stiahnuť



Registrovať

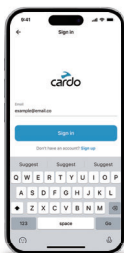

Vybrať jazyk

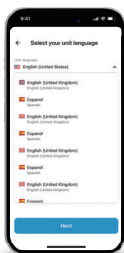

Aktualizovať software



 Zvýšiť hlasitosť



 Znížiť hlasitosť



 Hlasový asistent



 ZAP





 VYP





 Ďalšia skladba





 Predchádzajúca skladba





Telefónny hovor



Prijat' hovor

Stlačte ľubovoľné tlačidlo
pre prijatie hovoru

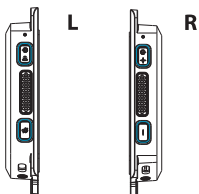

Ukončiť hovor



L

Mobilný interkom



Zoskupenie interkomu

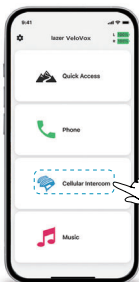

Cardo
Connect App
pre Lazer



Interkom ZAP/VYP



Stlmiť mikrofón



Zrušiť stlmenie mikrofónu



Obnovenie výrobných nastavení a reštart



Obnovenie výrobných nastavení

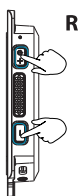

Reštart

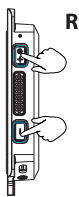

Obnovenie zvukovej jednotky



Obnovenie komunikačnej jednotky

Shimano pripojenie

Shimano párovanie

Di2
DIGITAL INTEGRATED INTELLIGENCE

- 1) Aktualizujte váš Di2 firmware.
- 2) Nastavte tlačidlá na Shimano Di2 prevodníkoch na D-Fly kanál pomocou Shimano E-Tube aplikácie.
- 3) Stlačte ľubovoľné tlačidlo na prevodníku pre párovanie.



SHIMANO
E-BIKE
SYSTEMS

- 1) Aktualizujte váš firmware.
- 2) Nastavte tlačidlá na Shimano EBIKE systémoch na D-Fly kanál pomocou Shimano E-Tube aplikácie.
- 3) Zapnite bicykel pre párovanie.

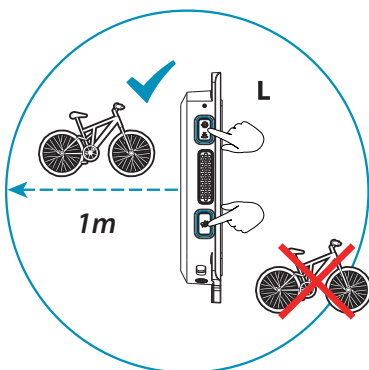

1. Nepárujte, keď je v blízkosti iný bicykel
2. Umiestnite bicykel nie ďalej ako 1 meter



Rôd & biá LED





9:41



Shimano connectivity

D-FLY channel 1

Short press:

Mic mute / unmute

Double press:

Cycling information

Long press:

Voice assistance

D-FLY channel 2

Short press:

Unable/ disable group co...

Double press:

Music on / off

Long press:

Answer / end call

D-FLY channel 3

Short press:

Volume up

Double press:

Next track

Long press:

+ Add action

D-FLY channel 4

Short press:

Volume down

Double press:

Previous track

Long press:

+ Add action

Prispôsobenie Shimano pripojenia



Otvoriť menu nastavení

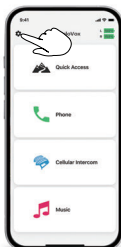

Otvoriť Shimano pripojenie

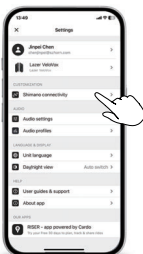

Zmeniť príkazy

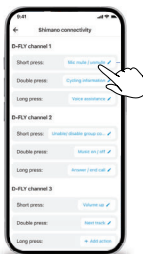

www.lazersport.com

LAZER

Reach out and follow us:

 @Lazersport

 LazerHelmets

 info@lazersport.com



Cardo
Connect App
for Lazer

Cardosystems.com/update

Cardosystems.com/support



LAZER

VeloVox

.....
TASKU JUHEND

Estonian

cardo CONNECT APP

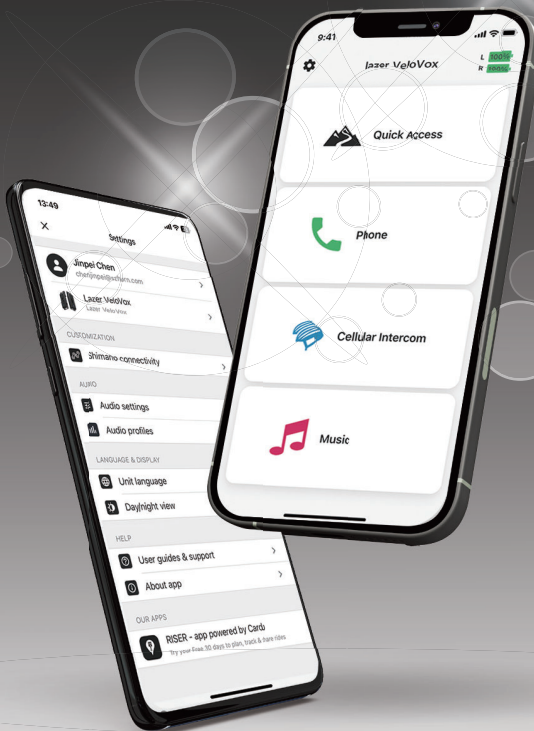

Cardo
Connect App
for Lazer



4-5

Alustamine

6

Cardo Connect rakendus

7

Üldine

8

Muusika

9

Telefonikõne

10

Mobiilne sisekõne süsteem

11

Tehase lähtestamine ja taaskäivitamine

Täpsemad funktsioonid

12

Shimano ühenduvus

13

Vaikeseaded

14

Shimano ühenduvuse kohandamine

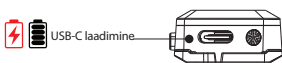
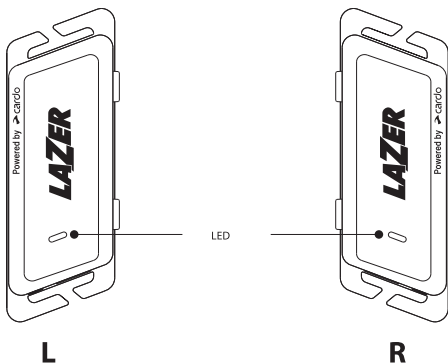

Vajuta ja Hoia



Puudutuste Arv

 SEES

Esimene kord: automaatne sidumine SEES



L



R

 VÄLJAS



L



R



 Vajadusel: alusta uut sidumist



R



Punane ja sinine LED 





Laadi alla

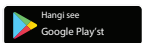
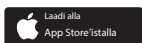

Registreeru

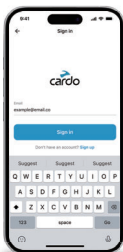

Vali keel

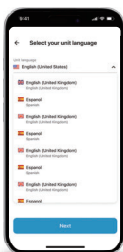

Uuenda tarkvara



 Heli tugevamaks



 Heli vaikumaks



 Häälassistent



▶ SEES



X2
Tap

|| VÄLJAS



X2
Tap

▶▶ Järgmine lugu



X2
Tap

◀◀ Eelmine lugu



X3
Tap

Telefonikõne



Vasta

Vasta telefonikõnele,
vajutades suvalist nuppu

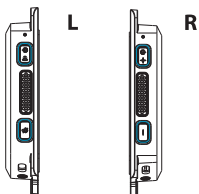

Lõpeta kõne



L



Mobilne sisekõne süsteem



Sisekõne grupeerimine



Cardo Connect
rakendus Laserile



Intercom SEES / VÄLJAS



Mikrofoni vaigistamine



Mikrofoni hääle sisselülitamine



Tehase lähtestamine ja taaskäivitamine



Tehase lähtestamine



Taaskäivitamine



Lähtesta heliseade



Lähtesta sideüksus

Täpsemad funktsioonid

Shimano ühenduvus



Shimano sidumine

Di2
DIGITAL INTEGRATED INTELLIGENCE

- 1) Uuenda oma Di2 püsivara.
- 2) Seadista Shimano Di2 käigukanginupp(u)d D-Fly kanalile Shimano E-Tube rakendusega.
- 3) Sidumiseks vajuta käigukangile suvalist nuppu.



SHIMANO
E-BIKE
SYSTEMS

- 1) Sidumiseks vajuta käigukangile suvalist nuppu.
- 2) Seadista Shimano EBIKE süsteemi nupud D-Fly kanalile Shimano E-Tube rakendusega.
- 3) Lülita jalgratas sisse sidumiseks.

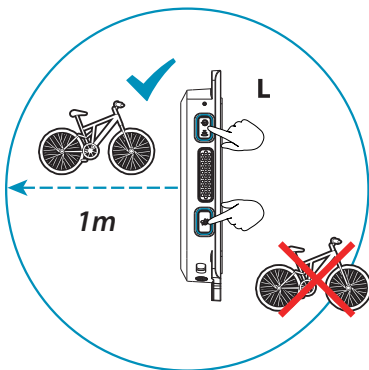

1. Ära sidu, kui läheduses on teine jalgratas
2. Aseta oma jalgratas mitte kaugemale kui 1 m



Punane ja sinine LED





Overview of default settings

9:41



Shimano connectivity

D-FLY channel 1

Short press:

Mic mute / unmute

Double press:

Cycling information

Long press:

Voice assistance

D-FLY channel 2

Short press:

Unable/ disable group co...

Double press:

Music on / off

Long press:

Answer / end call

D-FLY channel 3

Short press:

Volume up

Double press:

Next track

Long press:

+ Add action

D-FLY channel 4

Short press:

Volume down

Double press:

Previous track

Long press:

+ Add action

Shimano ühenduvuse kohandamine



Ava seadete menüü

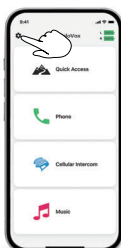

Ava Shimano ühenduvus

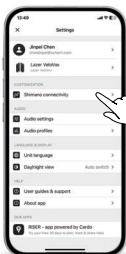

Muuda käske

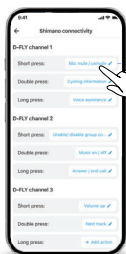

www.lazersport.com

LAZER

Reach out and follow us:

 @Lazersport

 LazerHelmets

 info@lazersport.com



Cardo
Connect App
for Lazer

Cardosystems.com/update

Cardosystems.com/support



LAZER

VeloVox

.....
KIŠENINIS VADOVAS

Lithuanian

cardo CONNECT APP

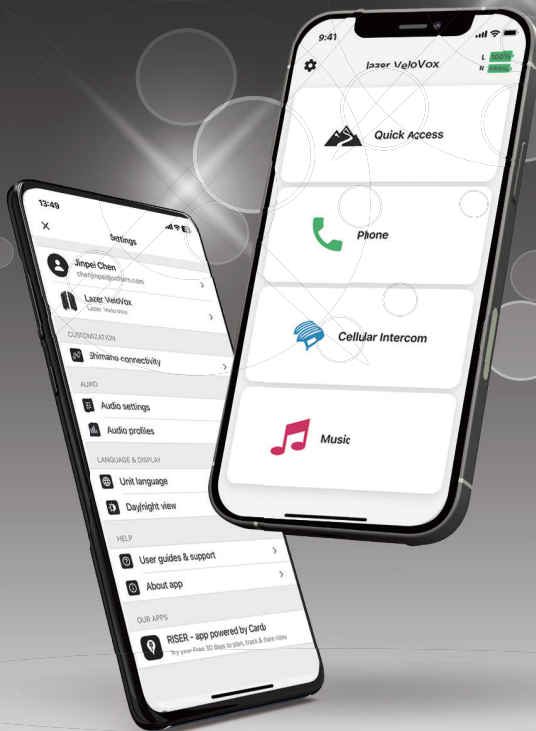

Cardo
Connect App
for Lazer



4-5

Pradžia

6

Cardo Connect programa

7

Bendras

8

Muzika

9

Telefono skambutis

10

Mobilus interkomas

11

Gamyklinių parametrų atstatymas ir paleidimas iš naujo

Išplėstiniai funkcionalumai

12

Shimano ryšys

13

Numatytieji nustatymai

14

Shimano ryšio pritaikymas

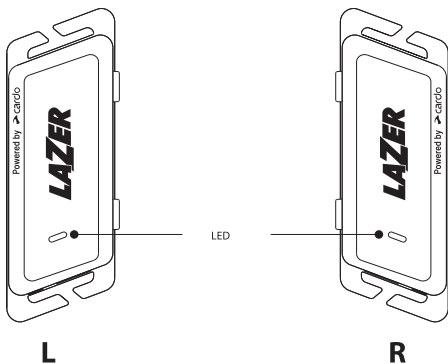

Paspausk ir palaikyk



Bakstelėjimų skaičius



ĮJUNGTA

Pirmas kartas: automatinis poravimas ĮJUNGTA



L



R



IŠJUNGTA



L



R



Jei reikia: pradėkite naują poravimą

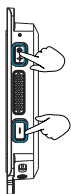

R



Raudonas ir mėlynas LED





Atsisiūsti

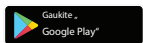
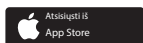

Registruotis



Pasirinkite kalbą

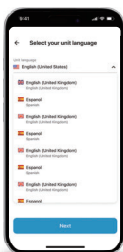

Atnaujinti programinę įrangą



 Garsas garsiau



 Garsas tyliau



 Balso asistentas



▶ ĮJUNGTAS



X2
Tap

⏸ IŠJUNGTA

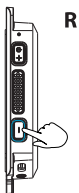

X2
Tap

▶▶ Kitas takelis



X2
Tap

◀◀ Ankstesnis takelis



X3
Tap

Telefono skambutis



Atsakyti

Atsakykite į skambutį,
paspausdami bet kurį
mygtuką

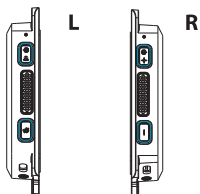

Baigti skambutį





Interkomų grupavimas



Cardo Connect
programa Lazerui



Intercom ĮJUNGTA / IŠJUNGTA



Mikrofono nutildymas



Mikrofono garsas įjungtas



Gamyklinių parametrų atstatymas ir paleidimas iš naujo



Gamyklinių parametrų atstatymas



Paleidimas iš naujo

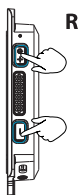

Atstatyti garso įrenginį



Atstatyti ryšio įrenginį

Išplėstiniai funkcionalumai

Shimano ryšys

Shimano poravimas

Di2
DIGITAL INTEGRATED INTELLIGENCE

- 1) Atnaujinkite savo Di2 programinę įrangą.
- 2) Nustatykite Shimano Di2 pavarų perjungiklio mygtuką (-us) D-Fly kanalui su Shimano E-Tube programa.
- 3) Poravimui paspauskite bet kurį pavarų perjungiklio mygtuką.



SHIMANO
E-BIKE
SYSTEMS

- 1) Atnaujinkite savo programinę įrangą.
- 2) Nustatykite Shimano EBIKE sistemos mygtukus D-Fly kanalui su Shimano E-Tube programa.
- 3) Įjunkite dviratį poravimui.

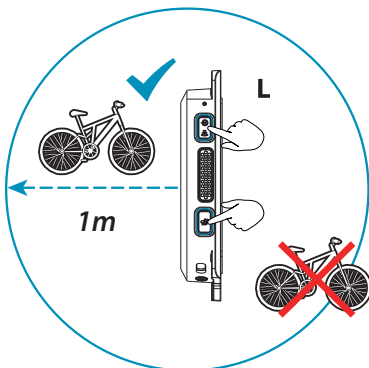

1. Neporaukite, kai šalia yra kitas dviratis
2. Padėkite dviratį ne toliau kaip 1 m atstumu



Raudonas ir mėlynas LED 



9:41



Shimano connectivity

D-FLY channel 1

Short press:

Mic mute / unmute

Double press:

Cycling information

Long press:

Voice assistance

D-FLY channel 2

Short press:

Unable/ disable group co...

Double press:

Music on / off

Long press:

Answer / end call

D-FLY channel 3

Short press:

Volume up

Double press:

Next track

Long press:

+ Add action

D-FLY channel 4

Short press:

Volume down

Double press:

Previous track

Long press:

+ Add action



Atidarykite nustatymų meniu

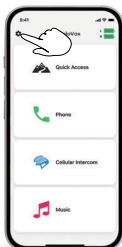

Atidarykite Shimano ryšį

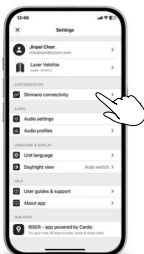

Keisti komandas

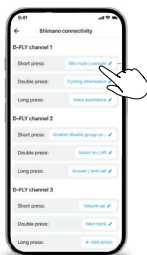

www.lazersport.com

LAZER

Reach out and follow us:

 @Lazersport

 LazerHelmets

 info@lazersport.com



Cardo
Connect App
for Lazer

Cardosystems.com/update

Cardosystems.com/support



LAZER

VeloVox

.....
KABATAS CEĻVEDIS
Latvian

cardo CONNECT APP

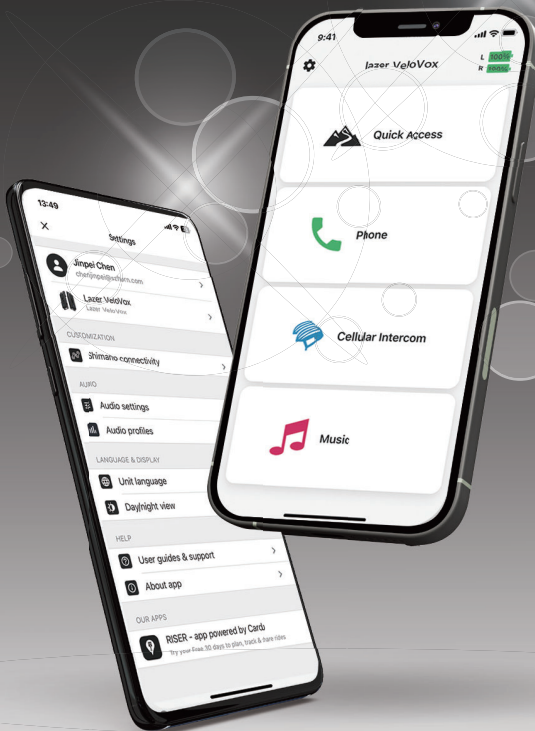

Cardo
Connect App
for Lazer



4-5

Sākam

6

Cardo Connect lietotne

7

Vispārējs

8

Mūzika

9

Tālruņa zvans

10

Mobilais starpsarunu tālrunis

11

Atjaunot rūpnīcas iestatījumus un pārstartēt

Paplašinātās funkcijas

12

Shimano savienojamība

13

Noklusējuma iestatījumi

14

Shimano savienojamības pielāgošana

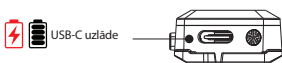
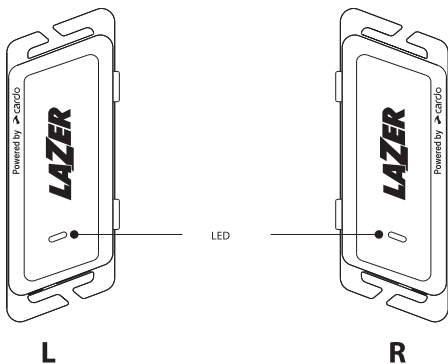

Nospied un Turi



Pieskārienu Skaits



IESLĒGTA

Pirmā reize: automātiskā savienošana IESLĒGTA



L



R



IZSLĒGTA



L



R



Ja nepieciešams: sākt jaunu savienošanu

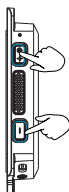

R



LED *Sarkans un Zils*





Lejupielādēt

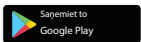
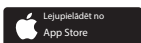

Reģistrēties



Izvēlieties valodu

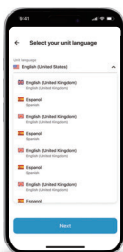

Atjaunināt programmatūru





Skaļums skaļāk



Skaļums klusāk



Balss asistents



Siri



Google Assistant

▶ IESLĒGTS



X2
Tap

|| IZSLĒGTS



X2
Tap

▶▶ Nākamā dziesma



X2
Tap

◀◀ Iepriekšējā dziesma



X3
Tap

Tālruņa zvans



Atbildēt

Atbildiet uz zvanu,
nospiežot jebkuru pogu

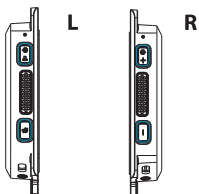

Beigt zvanu



L

Mobilais starpsarunu tālrunis



Starpsarunu grupēšana



Cardo Connect
lietotne Lazeram



Intercom IESLĒGTS / IZSLĒGTS



Mikrofona izslēgšana



Mikrofona ieslēgšana



Atjaunot rūpnīcas iestatījumus un pārstartēt



Atjaunot rūpnīcas iestatījumus

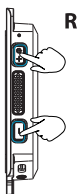

Pārstartēt

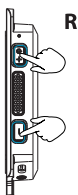

Atiestatīt audio bloku



Atiestatīt sakaru bloku

Paplašinātās funkcijas

Paplašinātās funkcijas

Shimano savienošana

Di2
DIGITAL INTEGRATED INTELLIGENCE

- 1) Atjauniniet savu Di2 programmaparatūru.
- 2) Iestatiet Shimano Di2 pārslēdzēju pogu (-as) D-Fly kanālam, izmantojot Shimano E-Tube lietotni.
- 3) Savienojuma izveidei nospiediet jebkuru pārslēdzēja pogu.



SHIMANO
E-BIKE
SYSTEMS

- 1) Atjauniniet savu programmaparatūru.
- 2) Iestatiet Shimano EBIKE sistēmas pogas D-Fly kanālam, izmantojot Shimano E-Tube lietotni.
- 3) Ieslēdziet velosipēdu savienošana.

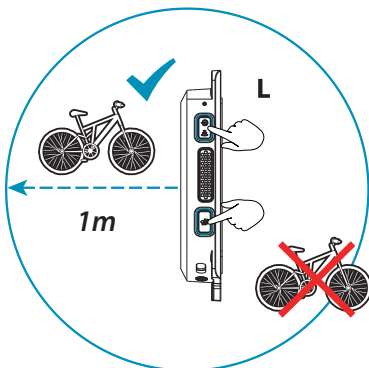

1. Neveido savienojumu, ja tuvumā ir cita velosipēds
2. Novietojiet savu velosipēdu ne tālāk par 1 metru



LED **Sarkans un Zils**





9:41



Shimano connectivity

D-FLY channel 1

Short press:

Mic mute / unmute

Double press:

Cycling information

Long press:

Voice assistance

D-FLY channel 2

Short press:

Unable/ disable group co...

Double press:

Music on / off

Long press:

Answer / end call

D-FLY channel 3

Short press:

Volume up

Double press:

Next track

Long press:

+ Add action

D-FLY channel 4

Short press:

Volume down

Double press:

Previous track

Long press:

+ Add action

Shimano savienojības pielāgošana



Atveriet iestatījumu izvēlni

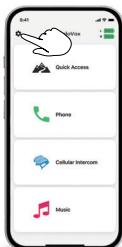

Atveriet Shimano savienojumu

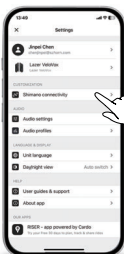

Mainīt komandas



www.lazersport.com

LAZER

Reach out and follow us:

 @Lazersport

 LazerHelmets

 info@lazersport.com



Cardo
Connect App
for Lazer

Cardosystems.com/update

Cardosystems.com/support



LAZER

VeloVox

מדריך כיס
Hebrew

cardo CONNECT APP

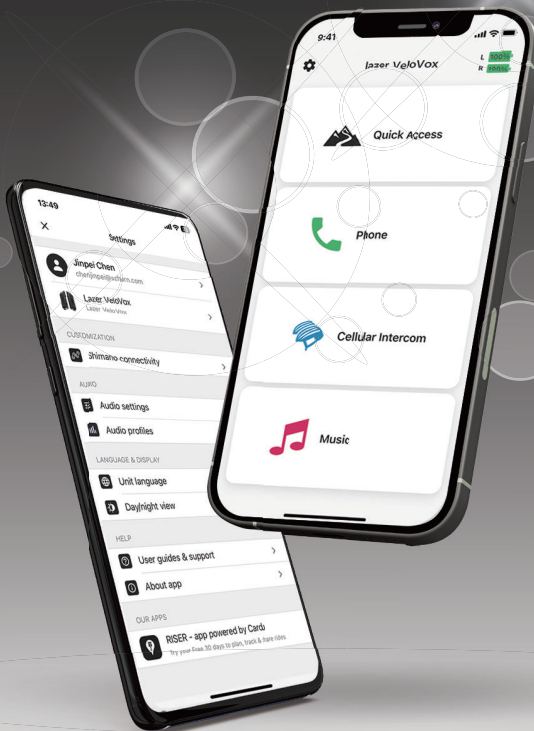

Cardo
Connect App
for Lazer



4-5

התחלה

6

אפליקציית Cardo Connect

7

כללי

8

מחיקה

9

שיחות טלפון

10

אינטרקום סלולרי

11

איפוס להגדרות יצרן והפעלה מחדש

תכונות מתקדמות

12

קישוריות Shimano

13

הגדרות ברירת מחדל

14

Shimano התאמה אישית של קישוריות

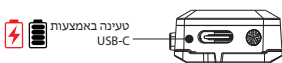
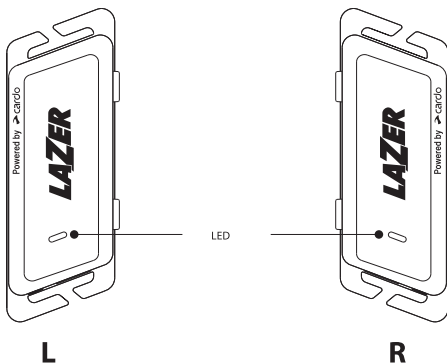

הפעלה 

בפעם הראשונה: התאמה אוטומטית (Pairing)



L



R

כבוי 



L



R



אם יש צורך: התחלת התאמה חדשה 



R



LED אדום וכחול



הורד



הרשם

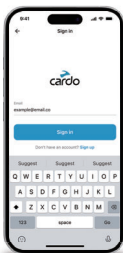

בחרשפה

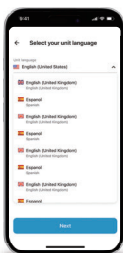

עדכוןתוכנה



הגברת עוצמה 



הנמכת עוצמה 



עוזר קולי 



Asistente de Google

הפעלה



כבוי



רצועה הבאה



רצועה קודמת



מענה 

לחץ על כל בפתור כדי
לענות לשיחה

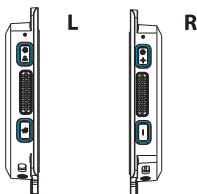

X1
Tap

סיום שיחה 

L

X1
Tap

קבוצת אינטרקום 

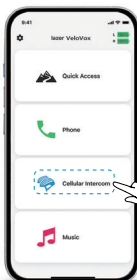

Cardo Connect אפליקציית עבר Lazer

אינטרקום הפעלה/כיבוי 



השתק מיקרופון 

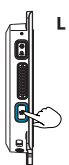

בטל השתקת מיקרופון 



איפוס להגדרות יצרן 

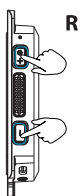

הפעלה מחדש 

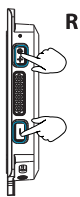

איפוס יחידת שמע



איפוס יחידת תקשורת



1. עדכן את הקושחה (firmware) של Di2.
2. הגדר כפתורים (ים) בשיפטים של Shimano Di2 לערוך D-Fly באמצעות אפליקציית Shimano E-Tube.
3. לחץ על כל כפתור בשיפטר לצורך צימוד.



4. עדכן את הקושחה שלך.
5. הגדר כפתורים (ים) במערכות Shimano EBIKE לערוך D-Fly באמצעות אפליקציית Shimano E-Tube.
6. הפעל את האופניים לצורך צימוד.

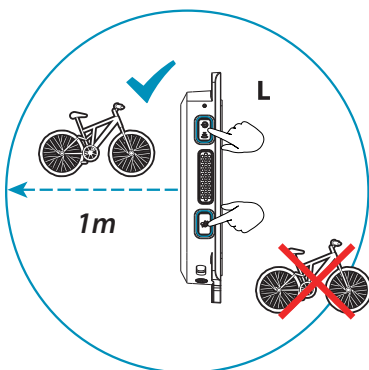

- 1) אל תבצע צימוד כשיש אופניים אחרים בסביבה
- 2) הנח את האופניים שלך במרחק שלא עולה על 1 מ'





9:41



Shimano connectivity

D-FLY channel 1

Short press:

Mic mute / unmute

Double press:

Cycling information

Long press:

Voice assistance

D-FLY channel 2

Short press:

Unable/ disable group co...

Double press:

Music on / off

Long press:

Answer / end call

D-FLY channel 3

Short press:

Volume up

Double press:

Next track

Long press:

+ Add action

D-FLY channel 4

Short press:

Volume down

Double press:

Previous track

Long press:

+ Add action

פתח תפריט הגדרות

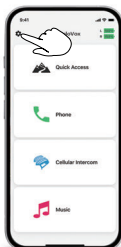

onamihS פתח קישוריות

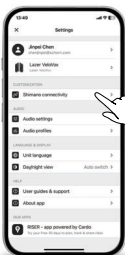

שנה פקודות

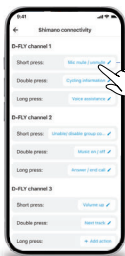

www.lazersport.com

LAZER

Reach out and follow us:

 @Lazersport

 LazerHelmets

 info@lazersport.com



Cardo
Connect App
for Lazer

Cardosystems.com/update

Cardosystems.com/support