

4 MOUNT THE CRADLE

4.b

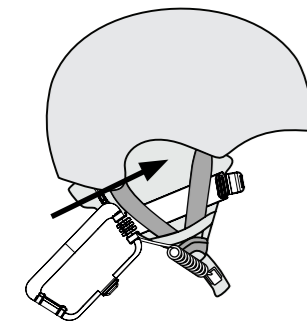

4.c

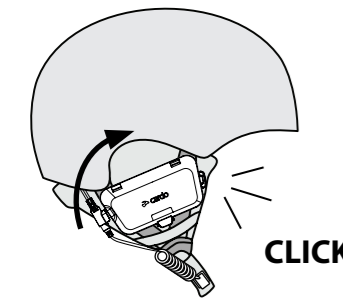

-9-

Option 2

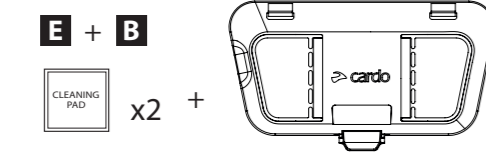
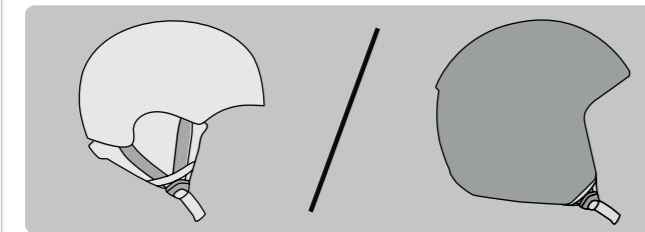

4.a*

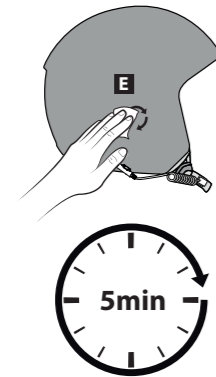

-10-

4.b*

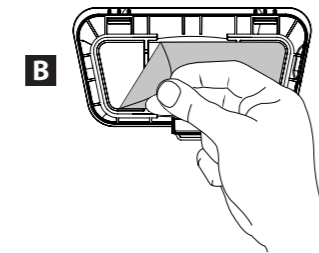

4.c*

Place under goggle strap
 Posiziona sotto il cinturino degli occhiali
 Colocar debajo de la correa de las gafas
 Placer sous la lanière des lunettes
 Unter dem Brillenband platzieren

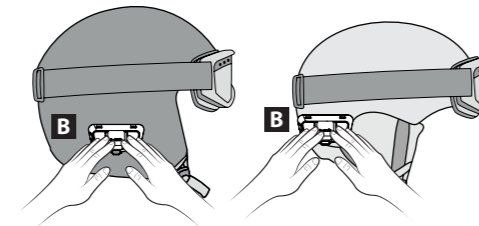

-11-

5 INSERT UNIT

5.a

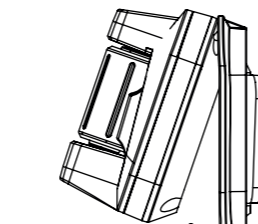
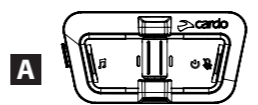

5.b

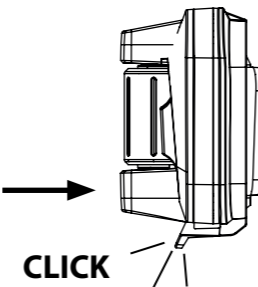

-12-

6 CONNECT AUDIO KIT

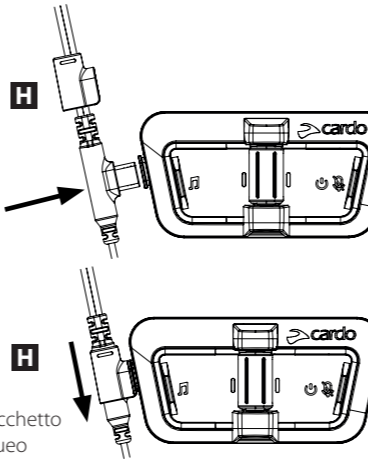

Slide the Lock
 Fai scorrere il lucchetto
 Deslizar el bloqueo
 Faire glisser la fermeture
 Sicherung aufschieben

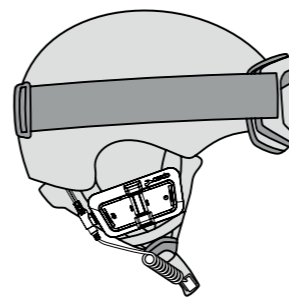

-13-

7 REMOVE THE UNIT

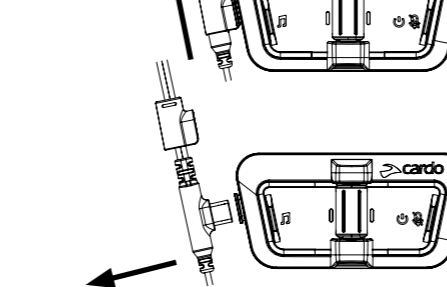

Press
 Premi
 Presionar
 Appuyer
 Drücken

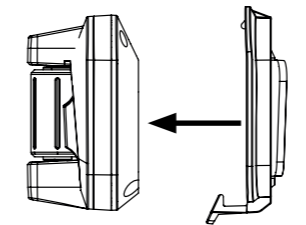

-14-

OPTIONAL: CONNECT YOUR OWN HEADPHONES

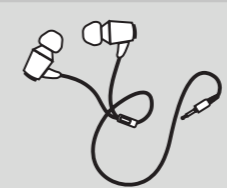

Not Included
 Non incluso
 No incluido
 Non inclus
 Nicht enthalten

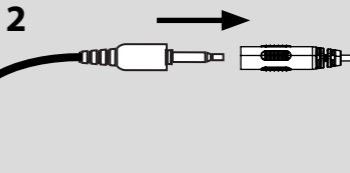
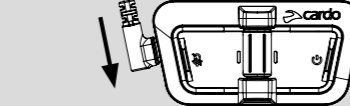
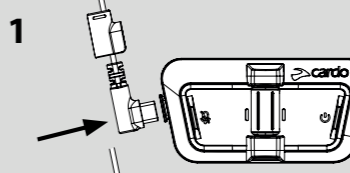
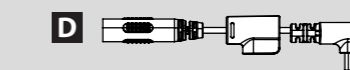

-15-

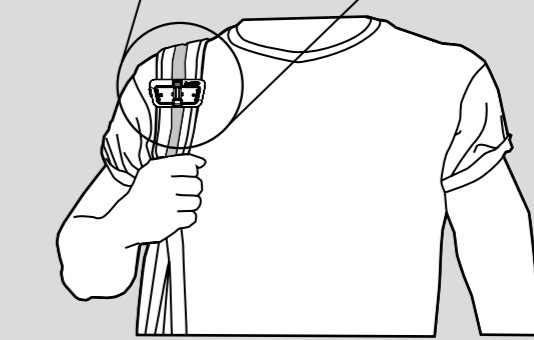
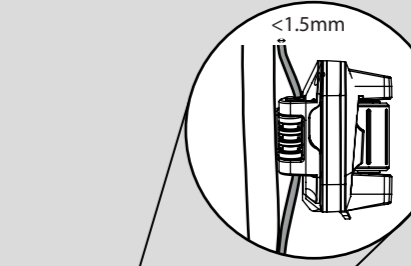
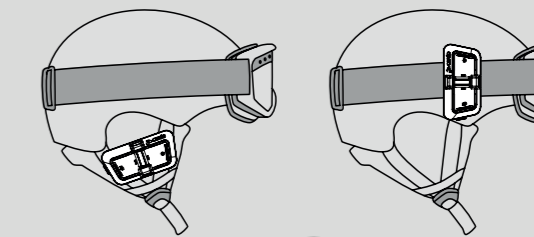

-16-

cardo

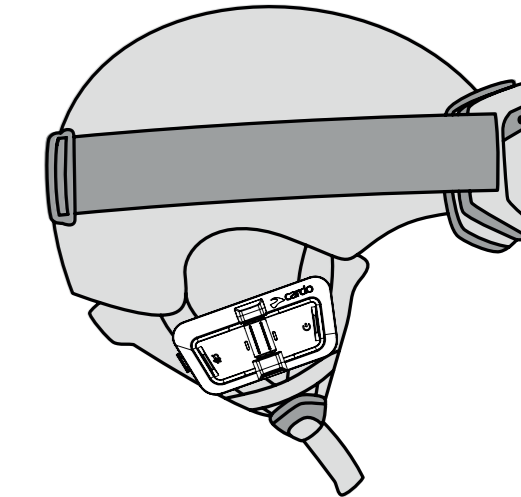

PACKTALK OUTDOOR

INSTALLATION GUIDE

EN/IT/SP/FR/DE

INSTRUCTOR CONTENTS

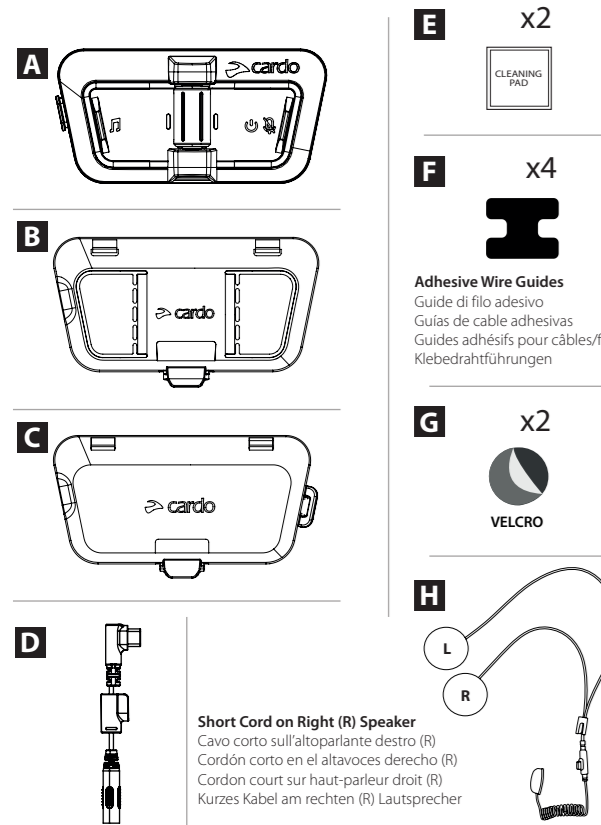

Short Cord on Right (R) Speaker
 Cavo corto sull'altoparlante destro (R)
 Cordon corto en el altavoces derecho (R)
 Cordon court sur haut-parleur droit (R)
 Kurzes Kabel am rechten (R) Lautsprecher

Installation Video
 Video d'installazione
 Video de instalación
 Vidéo d'installation
 Installationsvideo

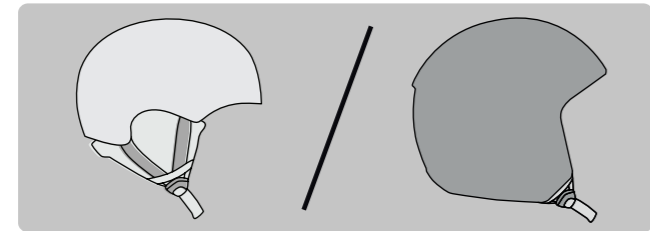

1 INSTALL THE SPEAKERS

Option 1: In Ear Pockets

Place speakers into ear pockets
 Posiziona gli altoparlanti nelle tasche per le orecchie
 Colocar los altavoces en los bolsillos
 Placer les écouteurs dans les étuis auriculaires
 Lautsprecher in die Polsterung einsetzen

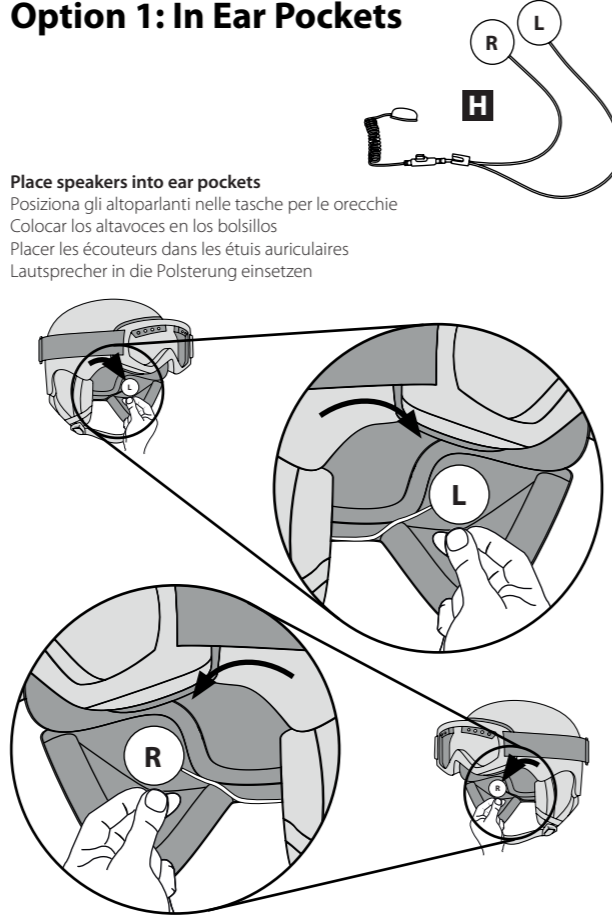

Option 2: Velcro on Inner Padding

G x2 + H

1.a

1.b

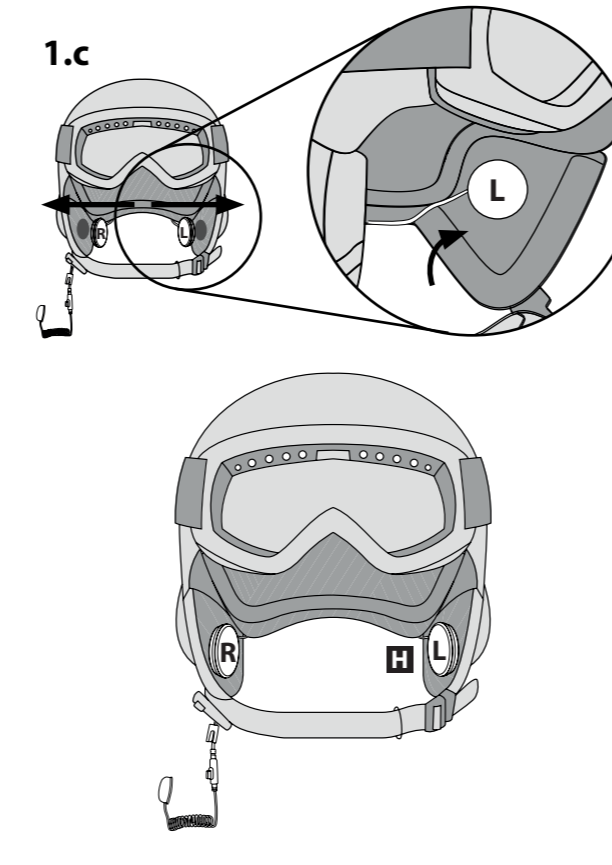
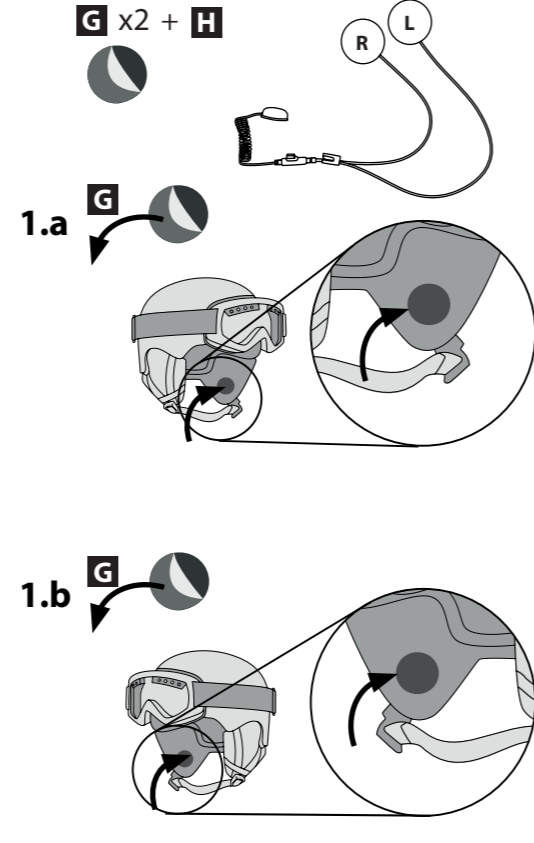

2 SET WIRE ON HELMET

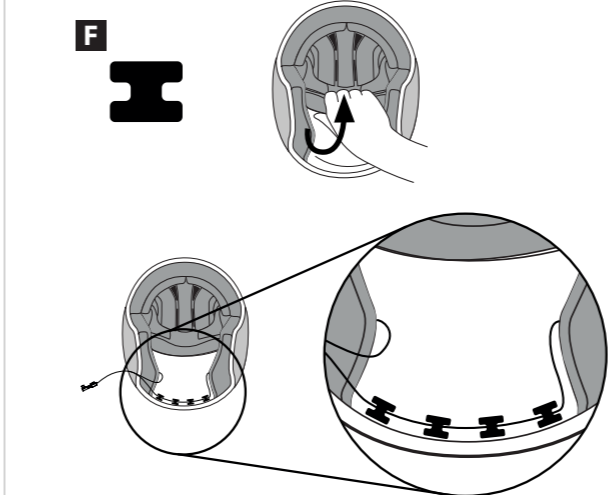

Position wire under padding and place stickers
 Posiziona il filo sotto l'imbottitura e applica gli adesivi
 Colocar el cable bajo el relleno y coloca las pegatinas
 Positionner le fil sous le coussinet et placer les autocollants
 Kabel hinter der Polsterung positionieren und Aufkleber anbringen

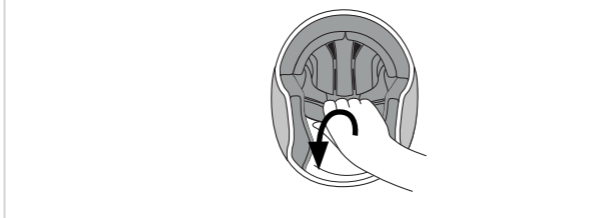

3 ATTACH THE MICROPHONE

3.a

3.b

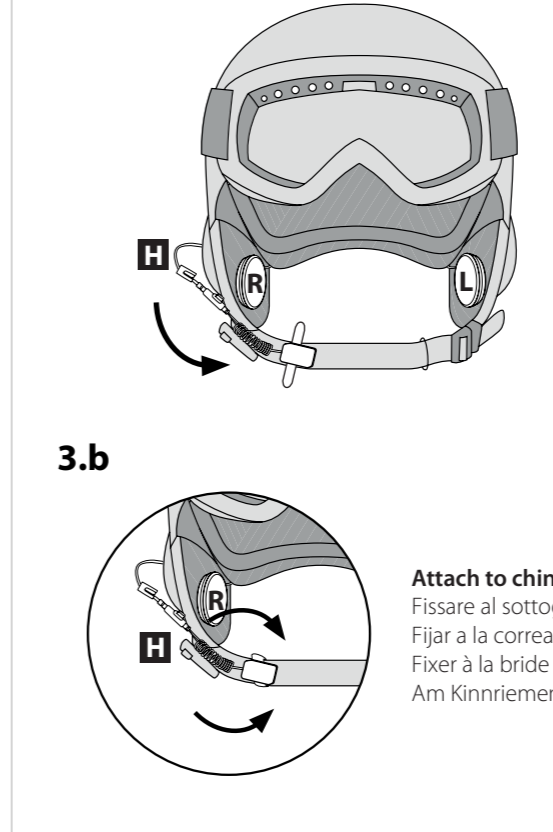

Attach to chin strap
 Fissare al sottogola
 Fijar a la correa de la barbilla
 Fixer à la bride du menton
 Am Kinnriemen befestigen

4 MOUNT THE CRADLE

Option 1

